

HUGO GERNSBACK, *Editor*

# RADIO CRAFT

*In this issue—*  
Television for Today  
Nomograph Construction  
Video Amplification

TRANSMITTER TUBE  
FOR TELEVISION  
SEE PAGE 608

JUNE  
1946

25¢

CANADA 30¢

RADIO-ELECTRONICS IN ALL ITS PHASES

# QUALITY

# SURE

# T TELLS



"Quality Sure Tells" is what "QST" means to hams who use Solar capacitors. Why? Simply because Solar sticks to its by-word "Quality Above All" year after year, giving hams capacitors that stand up under heavy duty in all climates.

Where every penny counts, as it does with most amateurs, Solar capacitors are the logical choice for the "most for your money"

Solar now has for you a NEW easy-to-use 36-page catalog, SC-1, showing the most complete line of capacitors for ham use—every type of capacitor from tiny tubulars to compact high-voltage oil papers. Slide your postcard request into the post box today, OM. We'll shoot your copy of the SC-1 back to you by return mail.

**SOLAR CAPACITOR SALES CORP.**  
285 MADISON AVENUE • NEW YORK 17, N. Y.



**ELECTROLYTIC, PAPER AND MICA CAPACITORS**

1252

# Be Your Own Boss



**I WILL SHOW YOU HOW TO START  
A RADIO SERVICE BUSINESS  
Full Time or Spare Time WITHOUT CAPITAL**

**SAMPLE LESSON FREE**

J. E. SMITH, President  
National Radio Institute  
Our 32nd Year of Training  
Men for Success in Radio

Let me show you facts about rich opportunities in Radio. See how knowing Radio can give you security, a prosperous future, and let you name your own hours as your own boss in your own Radio business. Send the coupon for FREE 64-page book, "Win Rich Rewards in Radio." Read how you practice building, testing, repairing Radios with SIX BIG KITS OF PARTS I send you. I will also send you FREE my sample lesson, "Getting Acquainted with Receiver Servicing."

## Future for Trained Men is Bright in Radio, Television, Electronics

The Radio Repair business is booming NOW. In your own spare time or full time Radio business you'll make good money fixing Radios, plus a good profit on Radio parts, and put yourself in line for more profits selling new Radios now that they can be made.

Trained Radio Technicians also find good pay opportunities in Police, Aviation, Marine Radio, in Broadcasting, Radio Manufacturing, Public Address Systems, etc. And greater opportunities are coming, when Television and Electronics are available to the public. Send for free book now!

## Many Beginners Soon Make \$5, \$10 a Week EXTRA in Spare Time

The day you enroll I start sending EXTRA MONEY JOB SHEETS to help you make EXTRA money fixing Radios in spare time while learning. You LEARN Radio principles from my easy-to-grasp lessons—PRACTICE what you learn by building real Radio Circuits, with Radio parts I send—USE your knowledge to make EXTRA money in spare time.

## Find Out What N.R.I. Can Do for YOU

MAIL COUPON for sample lesson and 64-page book, both FREE. The book is packed with facts about opportunities for you. Read the details about my Course. Read letters from men I trained telling what they are doing, earning. Just MAIL COUPON in an envelope or paste it on a penny postal. J. E. SMITH, President, Dept. 6FX, National Radio Institute, Pioneer Home Study Radio School, Washington 9, D. C.

## I TRAINED THESE MEN



**\$35-\$45 a Week  
In Own Shop**

"Previous to enrolling for your radio training I made \$12 per week in a hardware store. Now I operate my own repair shop, and often clear \$35 to \$45 a week."—FRED ERICK BELL, 76 Golf Ave., St. Johns, Newfoundland.



**Averages Over  
\$60 a Week**

"Not long ago I was working 16 hours a day in a filling station at \$10 a week. Now I have my own radio business and average over \$60 a week. The N.R.I. course is fine."—ALBERT C. CHRISTENSEN, 1116 10th Avenue, Sidney, Neb.



**\$50 a Week  
From Own Shop**

"Am making over \$50 a week profit from my own shop. Have another N.R.I. graduate working for me. I like to hire N.R.I. men because they know Radio."—NORMAN MILLER, Hebron, Neb.



You build this A. M. SIGNAL GENERATOR that gives you valuable experience. Provides amplitude-modulated signals for test and experiment purposes.

**LEARN RADIO BY  
PRACTICING  
IN SPARE TIME**

**with 6 Big Kits  
of Radio Parts  
I Send You**

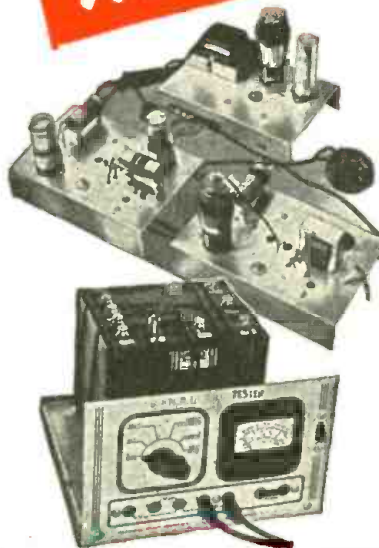

You Build this SUPERHETERODYNE CIRCUIT that brings in local and distant stations. You get practical experience putting this set through fascinating tests!

You Build this MEASURING INSTRUMENT yourself early in the course—use it for practical Radio work on neighborhood Radios to pick up EXTRA spare time money!

**GET BOTH 64 PAGE BOOK  
SAMPLE LESSON FREE**

J. E. SMITH, President, Dept. 6FX  
National Radio Institute, Washington 9, D. C.  
Mail me FREE, without obligation. Sample Lesson and 64-page book about how to win success in Radio and Television—Electronics. (No salesman will call. Please write plainly.)

Are .....  
Name .....  
Address .....  
City ..... Zone ..... State ..... ZIP

Approved for Training under GI Bill



MY COURSE INCLUDES TRAINING IN **Television • Electronics**

RADIO-CRAFT for JUNE, 1946

# SYLVANIA NEWS

## RADIO SERVICE EDITION

JUNE

Prepared by SYLVANIA ELECTRIC PRODUCTS INC., Emporium, Pa.

1946

# SYLVANIA SERVICEMAN SERVICE

by  
**FRANK FAX**



## RADIO SERVICE MAGIC

The trick is to find yourself on top of the world, happy, successful—enjoying increased profits as well as the goodwill of your community.

Also—to be accepted as *the* expert in your field, have a host of satisfied customers, a fast-growing business that will keep you on top of the world.

### HERE'S HOW IT'S DONE

This *radio service magic* is done with Sylvania national advertising—pages of it—that builds goodwill and does a lot of selling for you.

It's done with impartial, Sylvania coast-to-coast surveys that find interesting facts about the radio market, tell you what the public wants.

It's done with valuable business and technical aids for the radio serviceman—finger-tip data to help streamline your business, assure accurate servicing.

And for the *final touch*: Sylvania's *complete* line of receiving tubes. They mean satisfied service customers—the best source for bigger profits.

Your Sylvania Electric distributor has these famous tubes, plus a long list of aids to your business. Let him tell you more about this Sylvania *magic*, and the wonders it will do for you.

**MONEY-SAVING BUSINESS AIDS**

**WORK-SAVING TECHNICAL AIDS**

**SALES-ASSURING RADIO TUBES**

**FACT-FINDING NATIONAL SURVEYS**

**GOODWILL-BUILDING ADVERTISEMENTS**

# SYLVANIA ELECTRIC

Emporium, Pa.

MAKERS OF RADIO TUBES; CATHODE RAY TUBES; ELECTRONIC DEVICES; FLUORESCENT LAMPS, FIXTURES, WIRING DEVICES; ELECTRIC LIGHT BULBS

PLEASE PLACE YOUR ORDER WITH YOUR REGULAR RADIO PARTS JOBBER. IF YOUR LOCAL JOBBER CANNOT SUPPLY YOU, KINDLY WRITE FOR A LIST OF JOBBERS IN YOUR STATE WHO DO DISTRIBUTE OUR INSTRUMENTS OR SEND YOUR ORDER DIRECTLY TO US.



## The New Model CA-11 SIGNAL TRACER

Simple to operate . . . because signal intensity readings are indicated directly on the meter!

Essentially "Signal Tracing" means following the signal in a radio receiver and using the signal itself as a basis of measurement and as a means of locating the cause of trouble. In the CA-11 the Detector Probe is used to follow the signal from the antenna to the speaker — with relative signal intensity readings available on the scale of the meter which is calibrated to permit constant comparison of signal intensity as the probe is moved to follow the signal through the various stages.

### Features:

- ★ SIMPLE TO OPERATE — only 1 connecting cable — NO TUNING CONTROLS.
- ★ HIGHLY SENSITIVE — uses an improved Vacuum Tube Voltmeter circuit.
- ★ Tube and resistor-capacity network are built into the Detector Probe.
- ★ COMPLETELY PORTABLE — weighs 5 lbs. and measures 5" x 6" x 7".
- ★ Comparative Signal Intensity readings are indicated directly on the meter as the Detector Probe is moved to follow the Signal from Antenna to Speaker.
- ★ Provision is made for insertion of phones.

**\$18<sup>75</sup>**

The Model CA-11 comes housed in a beautiful hand-rubbed wooden cabinet. Complete with Probe, test leads and instructions.....Net price

## The New Model 450 TUBE TESTER



### Specifications:

- Tests all tubes up to 117 Volts including 4, 5, 6, 7, 7L, Octals, Loctals, Bantam Junior, Peanut, Television, Magic Eye, Hearing Aid, Thyratrons, Single Ended, Floating Filament, Mercury Vapor Rectifiers, etc. Also Pilot Lights.
- Tests by the well-established emission method for tube quality, directly read on the scale of the meter.
- Tests shorts and leakages up to 3 Megohms in all tubes.
- Tests individual sections such as diodes, triodes, pentodes, etc., in multi-purpose tubes.
- New type line voltage adjuster.
- NOISE TEST: Tip jacks on front panel for plugging in either phones or external amplifier will detect microphonic tubes or noise due to faulty elements and loose internal connections.
- Works on 90 to 125 Volts 60 Cycles A.C.

**SPEEDY OPERATION** assured by newly designed rotary selector switch which replaces the usual snap, toggle, or lever action switches.

The model 450 comes complete with all operating instructions.

Size 13"x12"x6".

Net weight 8 lbs. **\$39<sup>50</sup>**

Our Net Price.....

## New Model 400 ELECTRONIC MULTI-METER

A Combination Vacuum-Tube Voltmeter and Volt-Ohm Milliammeter plus Capacity, Inductance, Reactance, & Decibel Measurements



### Specifications:

- D.C. V.T.V.M. VOLTS: 0 to 3/15/30/75/150/300/750/1500/3000 Volts
  - D.C. VOLTS: (At 1,000 Ohms Per Volt) 0 to 3/15/30/75/150/300/750/1500/3000 Volts
  - A.C. VOLTS: (At 1,000 Ohms Per Volt) 0 to 3/15/30/75/150/300/750/1500/3000 Volts
  - D.C. CURRENT: 0 to 3/15/30/75/150/300/750 Ma. 0 to 3/15 Amperes
  - RESISTANCE: 0 to 1,000/10,000/100,000 Ohms 0 to 1/10/1,000 Megohms
  - CAPACITY: (In MFD) .0005—.2 .05—20 .5—200
  - REACTANCE: 10 to 5M (Ohms) 100—50M (Ohms) .01—5 (Megohms)
  - INDUCTANCE: (In Henries) .035—14 .35—140 35—14,000
  - DECIBELS: —10 to +18 +10 to +38 +30 to +58
- The model 400 comes housed in a rugged crackle-finished steel cabinet complete with batteries, two sets of test leads, one set of V.T.V.M. probes and instructions. Size 5 1/2" x 9 1/2" x 10".....Net **\$52<sup>50</sup>**



# SUPERIOR INSTRUMENTS CO.

Dept. R 227 FULTON ST., NEW YORK 7, N. Y.

# REPLACE CAPACITORS Faster...Better...at Less Cost



**NEW UNIVERSAL MOUNTING TYPE**  
Sprague Type LM Atoms for vertical chassis mounting. Replace any screw type can mounting. Fit any chassis hole from  $\frac{1}{8}$ " to  $\frac{1}{4}$ ". Have separate positive and separate negative leads.

## with SPRAGUE ATOMS



### NEW CATALOG—JUST OUT!

The finest, most complete and most helpful Sprague catalog ever issued! Contains complete details, dimensions, data, etc. on Sprague Capacitors and \*Koolohm Resistors for every service, amateur and experimental need. \*Trademark Reg. U. S. Pat. Off.

SEE US AT BOOTH 132—CHICAGO SHOW!

- Use them universally for ALL dry electrolytic replacements.
- A small supply equips you for ANY job—any voltage, capacity or capacity combination.
- Order them by name—be sure of getting genuine, factory-fresh Sprague Atoms—the kind that will not let you down.

**SPRAGUE PRODUCTS COMPANY**  
North Adams, Mass.

**JOBGING DISTRIBUTING ORGANIZATION FOR PRODUCTS OF THE SPRAGUE ELECTRIC CO.,**

RADIO-CRAFT for JUNE, 1946

# LET ME TRAIN YOU

for RADIO ELECTRONICS & TELEVISION

I'll Supply a **FULL RADIO SET**

for SIMPLIFIED INSTRUCTION — PRACTICE & TESTING

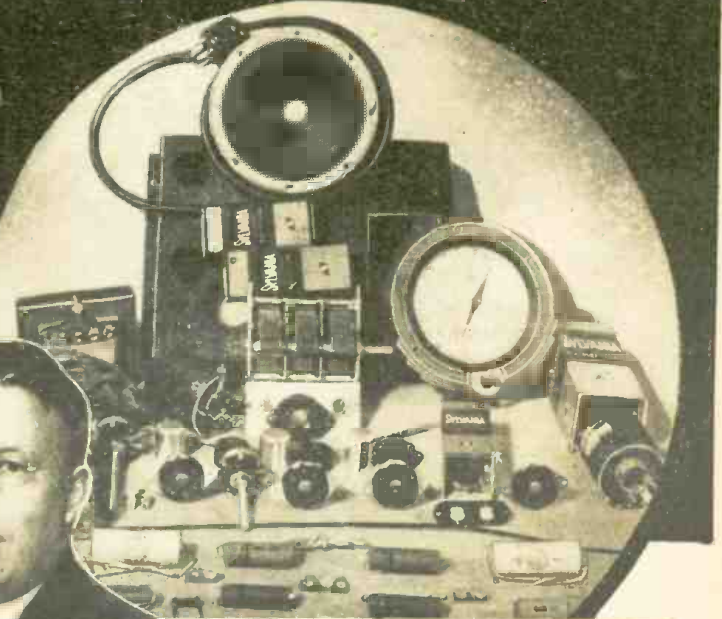

**Beginners Learn FAST**  
**START NOW!** Big Developments  
 Ahead in F. M., Radar, Television

**MAKE GOOD MONEY IN**  
**a Business of Your Own**  
**...or a Good Radio Job.**



Mind training through hand practice with a FULL RADIO SET... that's the interesting way I'll teach you Radio. And it's the latest, most practical method of all to fix in your head permanently the essential money-making Radio knowledge. The offer I make you here is the opportunity of a lifetime. I'll prepare you easily and quickly for a wonderful future in the swiftly expanding field of Radio-Electronics INCLUDING Radio, Television, Frequency Modulation and Industrial Electronics. Be wise! NOW'S the time to start. Opportunities ahead are tremendous! No previous experience is necessary. The Sprayberry Course starts right at the beginning of Radio. You can't get lost. It gets the various subjects across in such a clear, simple way that you understand and remember. And, you can master my entire course in your spare time... right at home.

**You Do Practical Experiments**

There's only one right way to learn Radio Electronics. You must get it through simplified lesson study combined with actual "shop" practice under the personal guidance of a qualified Radio Teacher. It's exactly this way that Sprayberry trains you... supplying real Radio parts for learn-by-doing experience right at home. Thus, you learn faster, your understanding is clear-cut.

**I'll Show You a New, Fast Way to Test Radio Sets Without Mfg. Equipment**

The very same Radio Parts I supply with your Course for gaining pre-experience in Radio Repair work may be adapted through an exclusive Sprayberry wiring procedure to serve for complete, fast, accurate Radio Receiver trouble-

shooting. Thus, under Sprayberry methods, you do not have one cent of outlay for manufactured Test Equipment.

**Succeed As a Radio-Electronician**

My training will give you the broad, fundamental principles so necessary as a background, no matter which branch of Radio you wish to specialize in. I make it easy for you to learn Radio Set Repair and Installation Work. I teach you how to install and repair Electronic Equipment. In fact, you'll be a fully qualified RADIO-ELECTRONICIAN, equipped with the skill and knowledge to perform efficiently and to make a wonderful success of yourself.

**Read What Graduate Says**  
**"One Job Nets About \$26.00"**

"Since last week I fixed 7 radios, all good-paying jobs, and right now I am working on an amplifier system. This job alone will net me about \$26.00. As long as my work keeps coming in this way, I have only one word to say and that is, 'Thanks' to my Sprayberry training, and I am not afraid to boast about it."—ADRIEN BENJAMIN, North Grosvenordale, Conn.

**DON'T PUT IT OFF!**

Get the facts about my training—now! Take the first important step toward the money-making future of your dreams. All features are fully explained in my big, illustrated FREE Catalog which comes to you along with another valuable FREE book you'll be glad to own.

## FREE BOOKS

"How To Read Radio Diagrams and Symbols"

Here's a valuable and wonderfully complete new book which explains in simple, non-technical English how to read and understand any Radio Set Diagram. Provides the quick key to analyzing any Radio circuit. Includes translations of all Radio symbols. This instructive volume is yours for the asking—without obligation. Send for it AT ONCE, and along with it I will send you another big free book, describing in complete, interesting detail my Radio-Electronic training.

**RUSH**  
**COUPON**  
 for **BOTH**



**SPRAYBERRY ACADEMY OF RADIO**  
 F. L. Sprayberry, President  
 Room 2066, Pueblo, Colorado

Please rush my FREE copies of "How to MAKE MONEY in RADIO ELECTRONICS and TELEVISION," and "How to READ RADIO DIAGRAMS and SYMBOLS."

Name ..... Ago.....

Address .....

City ..... State.....

(Mail in envelope or paste on penny postcard)

**MAIL COUPON AT ONCE!**

RADIO-CRAFT for JUNE, 1946

# RADIO CRAFT

AND POPULAR ELECTRONICS

Incorporating  
SHORT WAVE CRAFT TELEVISION NEWS  
RADIO & TELEVISION



HUGO GERNSBACK, *Editor-in-Chief*  
FRED SHUNAMAN, *Managing Editor*  
MAJ. M. H. GERNSBACK, *Cons'l'g Ed.*  
R. F. SCOTT, *Technical Editor*  
I. QUEEN, *Editorial Associate*  
ELMER FULLER, *Shortwave Editor*  
A. PASCALE, *Production Manager*  
G. ALIQUO, *Circulation Manager*  
JOHN J. LAMSON, *Advertising Director*  
ALFRED STERN, *Promotion Manager*

## IN THE NEXT ISSUE

The Transgenerator  
Cathode Followers  
Instability in Apparatus  
5-Tube Superheterodyne

Published by Radcraft Publications, Inc.  
Publication Office: 29 Worthington Street,  
Springfield 3, Mass.  
Editorial and Advertising Offices: 25 West  
Broadway, Tel. RE 2-9690. New York 7, N. Y.  
Chicago Advertising Office: Radio-Craft, 308  
W. Washington Street, Suite 1413, Chicago 6,  
Ill. Tel. Randolph 7363.  
Cleveland Advertising Office: 405 Erie Bldg.,  
Cleveland, Ohio. Burdette Phillips, Manager.  
Tel. Main 9645.  
Los Angeles Advertising Office: 606 South  
Hill Street, Los Angeles 14, Calif. Ralph W.  
Harker, Manager. Tel. Tucker 1793.  
San Francisco Advertising Office: 582 Market  
St., San Francisco 4, Calif. Ralph W. Harker,  
Manager. Tel. Garfield 2481.  
RADIO-CRAFT is published monthly on the  
25th of the month preceding that of date.  
Subscription rates: United States and pos-  
sessions, Mexico, Central and South American  
countries, \$2.50 a year, \$4.00 for two years,  
\$6.00 for three years. Canada, \$3.00 a year,  
\$5.00 for two years, \$7.50 for three years.  
All other foreign countries, \$3.25 a year,  
\$5.50 for two years, \$8.25 for three years.  
Special rates for members of the Armed  
Forces in U. S., or those addressed by A.P.O.  
or F.P.O. mail, \$2.00. Entered at the post  
office at Springfield as second-class matter  
under the Act of March 3, 1879. All com-  
munications about subscriptions should be  
addressed to: Circulation Manager, Radio-  
Craft, 25 West Broadway, New York 7, N. Y.

Notice of CHANGE of ADDRESS should  
reach us at least one month in advance. When  
ordering a change, please furnish an address  
stencil impression from a recent wrapper if  
you can. Address changes cannot be made  
without the old address as well as the new.

### Foreign Agents

London—Atlas Publishing and Distributing  
Co., Ltd., 18 Bride Lane, Fleet St., London,  
E.C. 4.  
Melbourne—McGill's Agency, 179 Elizabeth  
St., Australia.

Text and illustrations of this magazine are  
copyright and must not be reproduced without  
permission of the copyright owners.  
Copyright, 1946, Radcraft Publications, Inc.

RADCRAFT PUBLICATIONS, INC.:  
Hugo Gernsback, *President*  
Maj. M. Harvey Gernsback, *Vice Pres.*  
G. Aliquo, *Secretary*

## Contents June, 1946 Volume XVIII No. 9

Editorial: Why the Tube Shortage? .....	by Hugo Gernsback	601
Radio-Electronics Monthly Review .....		602
"Radio Pen" 28 Years Old .....		620
Radio Thirty-Five Years Ago .....		660
Two-Dimensional Radio .....		643

### ELECTRONICS

Television For Today .....	by Milton S. Kiver	604
FM Carrier Stabilization, Part II—Western Electric, Westinghouse, RCA Circuits .....	by I. Queen	605
High-Power U.H.F. Tube (Cover Feature) .....		608
Nomograph Construction, Part I—Nomographs for Current, Voltage and Resistance .....	by Fred Shunaman	609
Video Amplification .....	by Jordan McQuay	613
R.F. Power Supplies .....	by Nathaniel Rhita	616
H.F. Wideband Amplifier .....		645

### SERVICING

Mathematics—Radio Tool .....	by Arthur Howard & Morris Eddy	617
Reducing Hum Levels .....	by Jack King	619
Radio Data Sheet No. 336 (Belmont Model 6DIII, Series A) .....		615

### SOUND

Three-Channel Amplifier .....	by M. Contassot	607
-------------------------------	-----------------	-----

### CONSTRUCTION

Better Broadcast Tuner .....	by J. C. Hoadley	610
"Portarig" Ham Station .....	by Robert F. Scott	611
A.C.-D.C. "B" Battery .....		657

### TEST INSTRUMENTS

Adapting a Meter .....	by Alfred Shortcut	618
------------------------	--------------------	-----

### DEPARTMENTS

World-Wide Station List .....	by Elmer R. Fuller	622
New Radio Electronic Patents .....		623
New Radio-Electronic Devices .....		624
Radio Electronic Circuits .....		630
Try This One .....		632
The Question Box .....		634
Technotes .....		644
Available Radio-Electronic Literature .....		646
Why Not? .....		649
Communications .....		656
Book Reviews .....		659

*Biographical Portrait Drawings by Constance Joan Naar*



### ON THE COVER

A new ultra-high-frequency triode transmitting tube is being sealed off on our cover this month. The two halves of the tube are brought together and heated gradually by rotation over the flames below. The operator aids the job of sealing off with super-hot flame from the torch in his hand.

*Chromatone by Alex Schömburg from Federal Radio & Tel. photo.*



*See* how readily YOU can train at home for **BIGGER EARNINGS**

# in RADIO ELECTRONICS



**FREE KIT PACKET SHOWS HOW YOU CAN GET LOTS OF "LEARN-BY-DOING" RADIO EXPERIENCE AT HOME FROM DEFOREST'S THRILLING RADIO**

## "Home Laboratory"

Now—you can see for yourself why DeForest's Training does such a grand job of preparing men for a bright future in one of America's most promising opportunity fields—Radio and Electronics. Send the coupon below for your free "Kit Packet" plus the big free book, "Victory For You!" that has helped so many to find the way to good pay jobs. You'll be surprised at the opportunities ahead of FM Radio, Aviation Radio, Broadcast Radio, a profitable Business of Your Own, Motion Picture Sound Equipment, and Electronics—plus the exciting future possibilities ahead of Television, Radar, etc. Train in your spare time at home—or get all of your training in our Chicago laboratories.

### 133 EXPERIMENTS

DeForest's Kit Packet shows how you can get real Radio experience from the many standard Radio parts furnished you with DeForest's Training. See how you may quickly build Radio Circuits that work... how you may experiment with Photo Electric Cell "Magic"... a 5-Tube Superheterodyne Receiver... a Radio Telephone and scores of other fascinating projects. See how you get actual "shop training" at home to give you the practical Radio experience you need.

### VETERANS!

Big things are happening at De Forest's for veterans! See how you can prepare yourself without cost for a GOOD JOB or BUSINESS OF YOUR OWN in the vast Radio-Electronic opportunity field.

#### DEFOREST'S PROVIDES ALL 3 HOME TRAINING AIDS

- A** DeVry Movie Projector and Learn-By-Seeing Movie Film
- B** Actual Radio Parts for working out 133 experiments
- C** 90 lessons prepared under the supervision of Dr. Lee DeForest—the "Father of Radio."

### You Also Get EFFECTIVE EMPLOYMENT SERVICE

Upon completing your training, you get the full benefit of DeForest's Employment Service that has helped so many men to get started in the Radio-Electronic field.



DEFOREST'S TRAINING INCLUDES INSTRUCTION IN MOTION PICTURE SOUND EQUIPMENT, FM RADIO AND TELEVISION RESIDENTIAL TRAINING IN OUR MODERN CHICAGO LABORATORIES ALSO AVAILABLE—ASK US FOR INFORMATION!



E. B. DeVry, President  
**DEFOREST'S TRAINING, INC.**  
 2535-41 North Ashland Ave., Dept. RC-C6  
 Chicago 14, Illinois, U.S.A.  
 Send FREE RADIO KIT PACKET and "VICTORY FOR YOU!" BOOK.

Name \_\_\_\_\_ Age \_\_\_\_\_  
 Address \_\_\_\_\_ Apt. \_\_\_\_\_  
 City \_\_\_\_\_ Zone \_\_\_\_\_ State \_\_\_\_\_  
 If under 16, check here for special information.  If a discharged Veteran of World War II, check here.

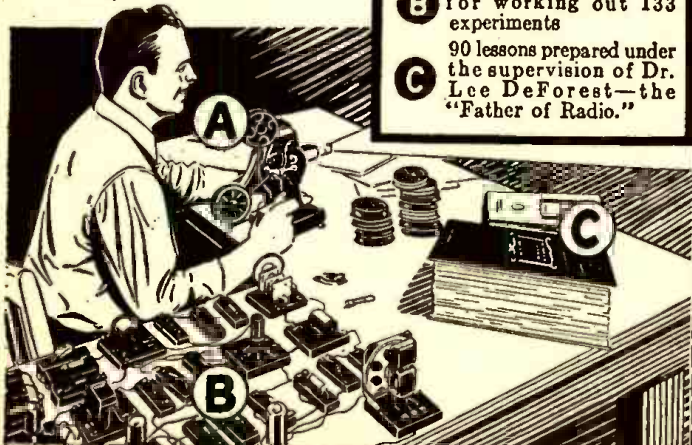

**DEFOREST'S TRAINING, INC.**  
 CHICAGO 14, ILLINOIS

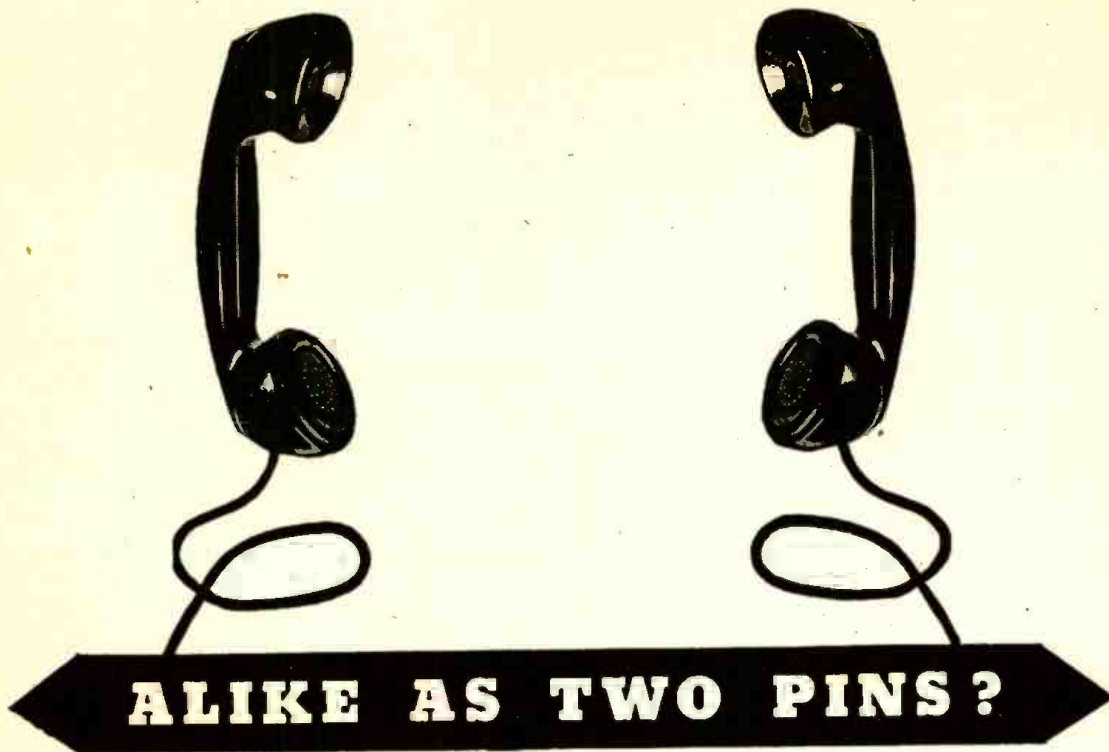

**Y**es, or alike as two telephone handsets made by the same process. Yet, pins or handsets — no two could ever be made exactly alike. Dimensions, weight, performance — all vary every time due to variables in manufacture. How can these variables be controlled?

Back in 1924, Bell Laboratories' mathematicians and engineers teamed up to find out, forming the first group of quality-control specialists in history. They invented the now familiar Quality Control Chart, designed inspection tables for scientific sampling. They discovered that test data mathematically charted in the light of probability theory were talking a language that could be read for the benefit of all industry.

Western Electric, manufacturing branch of the Bell System, applied the new science to its large-scale production. In war, it was used by industrial and government agencies of the United Nations in establishing and maintaining standards for military matériel. A Quality Assurance Department, a novelty back in the nineteen-twenties, has come to be indispensable to almost every important manufacturer.

Scientific quality control is one of many Bell Laboratories' ideas that have born fruit in the Bell System. The application of mathematics to production helps good management all over the industrial world — and furthers the cause of good telephone service.



### **BELL TELEPHONE LABORATORIES**

EXPLORING AND INVENTING, DEVISING AND PERFECTING FOR CONTINUED IMPROVEMENTS AND ECONOMIES IN TELEPHONE SERVICE.

Grasp the **NEW OPPORTUNITIES** in

# RADIO ELECTRONICS AND TELEVISION NOW!

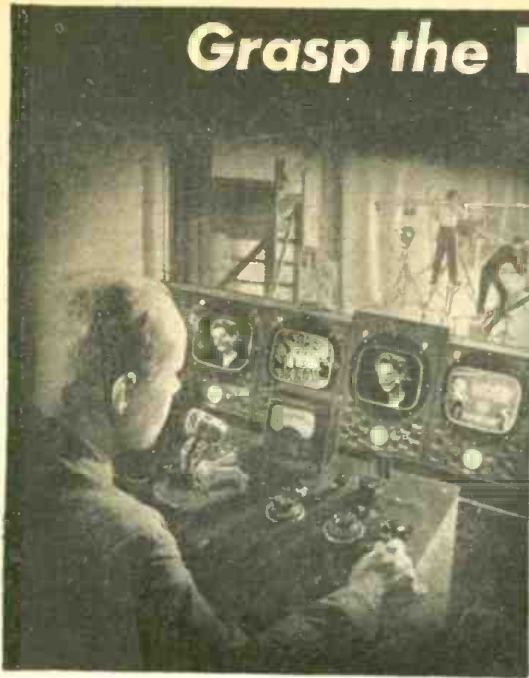

Modern Radio — F M broadcast and reception —  
Television — Radar — Industrial Electronics;  
power, control, communications—new equipment  
and methods demand new technical ability and  
experience. Keep up to date with the latest.

## MODERN ELECTRONIC LABORATORY FOR YOU TO USE AND KEEP

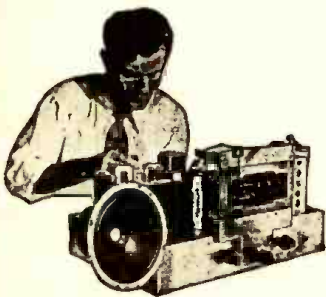

The very essence of National Shop Method Home Training is **EXPERIENCE**. You get the actual experience by working with modern Radio and Electronic equipment—building circuits and instruments. You may build a fine, long distance **MODERN SUPERHETERODYNE**, signal generator, miniature radio transmitter, audio oscillator—many other full sized, actual, operating pieces of equipment and instruments—conduct cathode ray and hundreds of other experiments. This experimental laboratory work advances with your training and you actually learn by doing. Send the coupon and get the full details of how such an offer can be made.

## See What National Training Has Done For These Men!

National Shop Method Home Training wins good jobs, independence and security quickly. Take the word of National men who have established records in their favorite Radio, Television, or other branches of Electronics:



Joseph Grumlich, Lake Hiawatha, New Jersey writes: "My latest offer was \$5,000.00 as Radio Photo Engineer but I'm doing well where I am now engaged, I am deeply indebted to National."



Here's a statement from R. R. Wright, Blackfoot, Idaho: "Due to my training at National I was selected to instruct in the laboratory work of Navy and Marines."



Robert Adamsen, Kearney, Nebraska, a National Graduate, has two radio jobs—makes double pay as a radio instructor and as engineer at Station KGFW. He writes: "I am proud of My National training and appreciate the cooperative spirit."

Read what hundreds of other enthusiastic students have written about National Training. Send in your coupon today.



From O. K. Ivey, Washington, D. C., comes this endorsement: "I believe National offers the best course to be had. Keep up the good work."



Keep up the good work.

Learn right! Get the latest short cuts, trade secrets, straight information.

## Shop Method Home Training By a Great Established Resident School

Get one of the thousands of **NEW JOBS** that demand new techniques and methods in modern radio. Get your share of the **NEW BUSINESS** that servicing the new sets and equipment demands. Experts agree that Radio Television and Electronics presents the next great industrial boom!

Radio is expanding farther and faster than ever with great improvements in reception. Radar is already a 2-billion dollar a year business. No one knows yet how great the Television market will be. Electronics touches almost every walk of life—in industry and in the home.

**TURN YOUR INTEREST IN RADIO INTO A CAREER THAT WILL ASSURE YOUR SUCCESS.** Mail the coupon below for a list of the great opportunities in this field—today and in the near future.

### Get the Proper Training

The good jobs in Radio Electronics now go to the men who are equipped to handle them. It takes training and experience. National Schools, one of the oldest and best established technical trade schools in the country, makes it possible for you to get this training and experience right in your own home **IN YOUR SPARE TIME.**

National maintains one of the biggest resident training shops and laboratories in the United States where instructors, scientists and engineers are working constantly to improve and advance training methods. **SHOP METHOD HOME TRAINING** is a logical extension of this practical system.

A **FREE** lesson that shows you how practical and systematic—how sound, simple and easy this new training method is will be sent you without obligation. You may keep and use this lesson as you see fit. Fill out and mail the coupon below.

### Investigate this Proposition

Where do you stand today in modern industrial progress? What does the future hold for you? You owe yourself this opportunity. It may never come again. With National Training **YOU GET AHEAD FAST**—you may step into a good position or start a business of your own, with little or no capital, even before you complete your National course.

Fit yourself for a career of independence, good earnings, a lifetime of success and security in one of the fastest growing fields in the World. But make up your own mind. Get the information first hand. Put your name and address on the coupon and mail it today.



## Get This Book FREE

This big book presents the facts about the field of electronics and your opportunities in it together with full information about the advanced National Training. Read it and make up your own mind that National Training will equip you for a great future. No salesman will call on you from National. The book is **FREE** with your sample lesson. Send the coupon or write.

## FREE LESSON

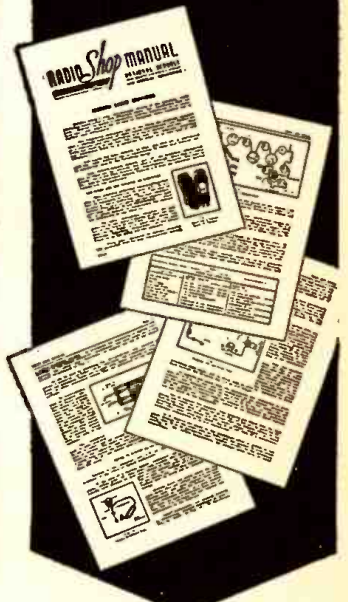

## NATIONAL SCHOOLS

LOS ANGELES 37, CALIFORNIA EST. 1905



### MAIL OPPORTUNITY COUPON FOR QUICK ACTION

National Schools, Dept. RC-6  
4000 South Figueroa Street, Los Angeles 37, California

(Mail in envelope or paste on penny post card)

Mail me **FREE** the two books mentioned in your ad including a sample lesson of your course. I understand no salesman will call on me.

NAME ..... AGE.....

ADDRESS .....

CITY ..... STATE.....

Include your zone number

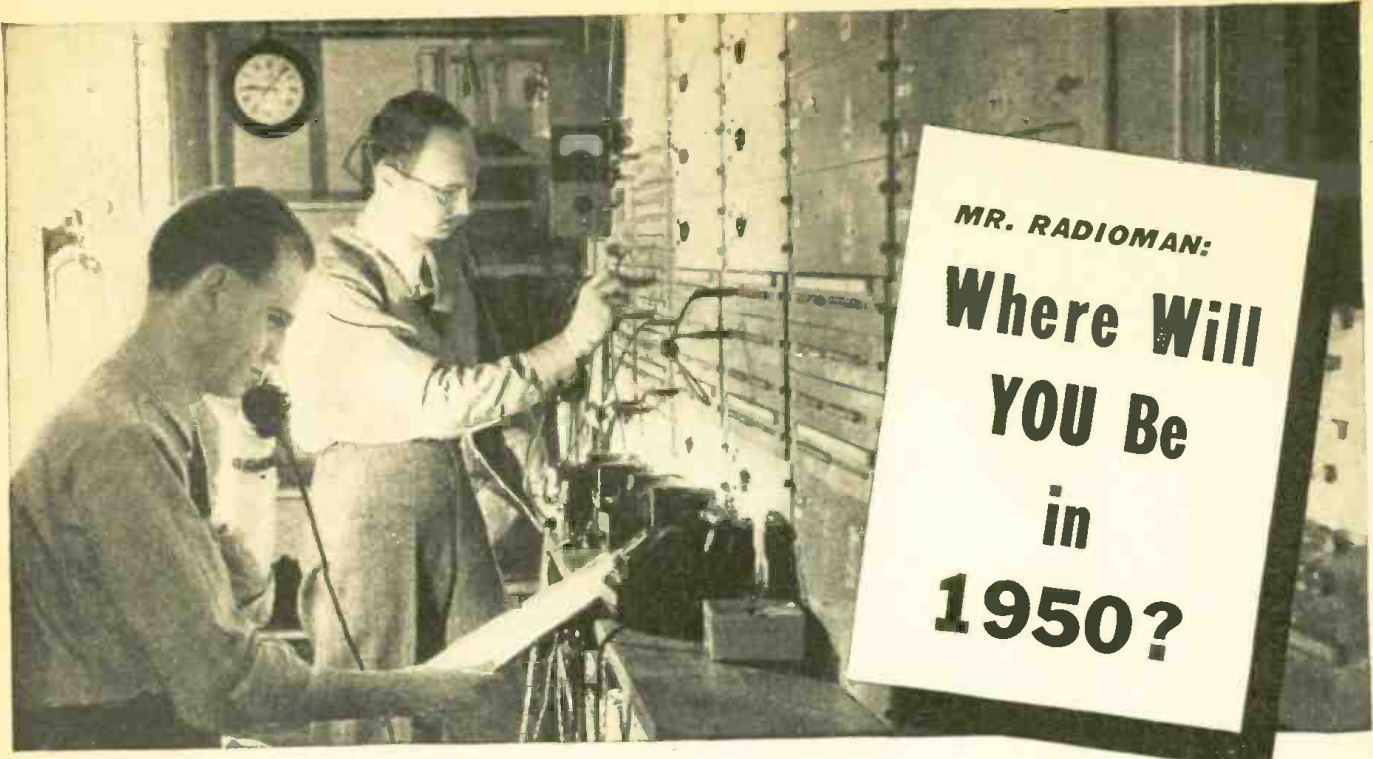

**Enjoy Security and Good Pay! Prepare Now with CREI Technical Home Study Training and Step Ahead of Competition into a Good Radio Job! CREI Offers You a Proved Program of Self Improvement to Keep Pace with Modern U.H.F. Advancements and Enables You to Go After -- and Get -- a Secure Radio Engineering Job.**

Yes, there are GOOD JOBS . . . for GOOD men! The easy jobs are gone and once again knowledge and ability are the requirements for the good-paying jobs. Competition is opening up. The fight to HOLD good jobs—to SECURE better ones is just starting. Employers once again can afford to be "choosy" . . . to select the best man for the best job. In the face of this show-down situation—where do YOU stand? CREI graduates are recognized throughout the Radio-Electronics Industry. Your CREI diploma is the best recommendation for a better job.

CREI home study training in Practical Radio-Electronics Engineering can equip you to meet the requirements to hold your job—or advance to a better one. No matter what your past radio-electronics experience has been—no matter what your training—you must actually start anew to gain the confidence born of knowledge. By adding CREI training to your present radio experience you can safeguard your future and keep pace with such new developments as U.H.F. Circuits, Cavity Resonators, Pulse Generators, Wave Guides, Klystrons, Magnetrons and other tubes. Are you equipped to handle them? CREI is equipped to help you, by providing the know-how and ability that is required.

In our proved method of instruction, you learn not only how but why! Easy-to-read-and-understand lessons are provided well in advance, and each student has the benefit of personal guidance and supervision from a trained instructor. This is the basis of the CREI method of training which many thousand professional radiomen have completed since 1927. CREI courses were used during the war to train thousands of Army and Naval radio technicians for the U. S. Signal Corps, U. S. Navy and U. S. Coast Guard.

It's up to you now to decide your course. What you do today will be the answer to where you will be in 1950 and the years after. It costs you nothing to read the interesting facts . . . to learn how CREI can help you enjoy the security you want . . . the better-paying job that can be yours. Write for particulars now! CREI training for Veterans is approved under the "G.I." Bill.

# Capitol Radio Engineering Institute

E. H. RIETZKE, President

Dept. RC-6, 16th and Park Road, N. W., Washington 10, D. C.

**Branch Offices:**

New York (7): 170 Broadway  
San Diego (1): 316 C Street

Chicago (2): 30 N. LaSalle Street  
San Francisco (2): 760 Market Street

• WRITE TODAY for FREE BOOKLET



"Your Opportunity in the New World of Electronics"

• Tells how CREI Courses can be adapted to your particular needs. If you have had professional or amateur experience—let us prove to you that we have something you need to qualify for a better radio job. To help us to intelligently answer your inquiry—PLEASE STATE BRIEFLY YOUR BACKGROUND OF EXPERIENCE, EDUCATION AND PRESENT POSITION.

Member: NATIONAL HOME STUDY COUNCIL • NATIONAL COUNCIL OF TECHNICAL SCHOOLS

RADIO-CRAFT for JUNE, 1946

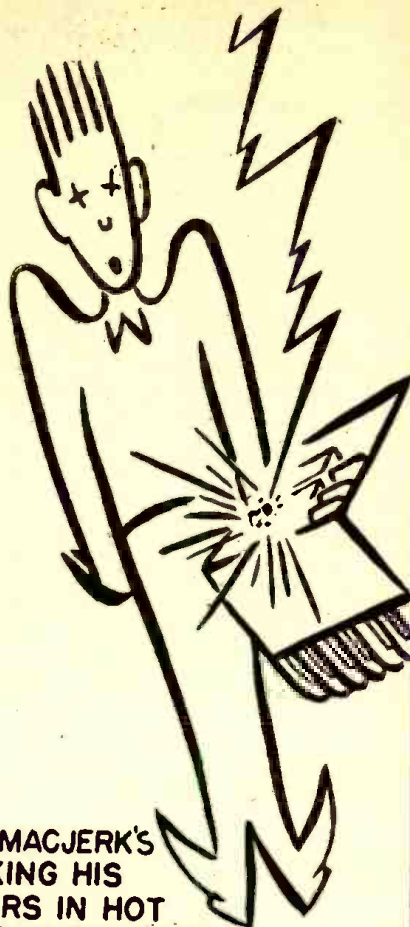

JOE MACJERK'S  
STICKING HIS  
FINGERS IN HOT  
TELEVISION SETS  
AGAIN!

LAST TIME  
THE BOSS SWORE  
HE'D CUT JOE'S  
SALARY AND BUY  
"RADIO  
MAINTENANCE"  
FOR HIM!

VIC TURNER

For  
optimum  
performance  
in the  
service  
field  
**USE**  
Radio  
Maintenance  
Magazine.

*Special offer to  
Radio Servicemen*

**Articles monthly on:**

- Television — AM — FM
- Public Address Systems
- Test Equipment — Tools — Service Kit
- Shop Layout — Service Bench
- Trouble Shooting
- Business News

**Radio Maintenance  
is not sold on  
newsstands**

**RADIO MAINTENANCE MAGAZINE  
460 BLOOMFIELD AVE., MONTCLAIR, N. J.**

Please send me  
**RADIO MAINTENANCE**

- For 1 year 2.00  
 For 2 years 3.00

NAME \_\_\_\_\_

OCCUPATION \_\_\_\_\_

ADDRESS \_\_\_\_\_

CITY \_\_\_\_\_

ZONE \_\_\_\_\_ STATE \_\_\_\_\_

CHECK ENCLOSED\*

BILL ME LATER

\*NOTE: By enclosing payment,  
thus eliminating billing expense

**WE WILL ADD ONE ISSUE FREE!**

RC-6

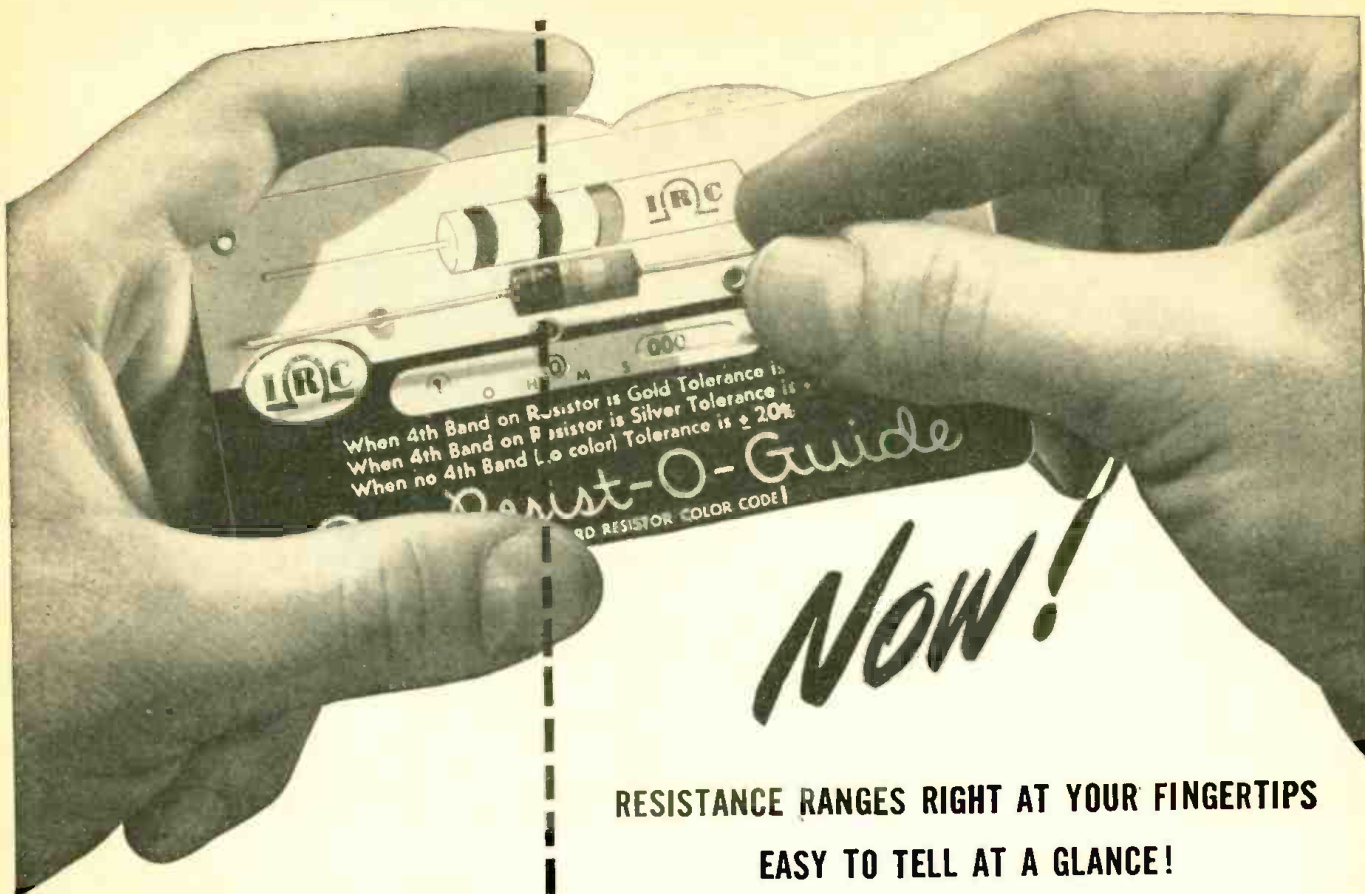

*Now!*

**NEW...**  
**HANDY...**  
**QUICK...**  
**ACCURATE...**

**RESISTANCE RANGES RIGHT AT YOUR FINGERTIPS**  
**EASY TO TELL AT A GLANCE!**

**HERE'S SOMETHING NEW**—The RESIST-O-GUIDE, a practical aid in resistor range identification for every Radio Serviceman, Ham, Electrical Designer and Electronic Engineer.

To use the pocket size RESIST-O-GUIDE simply turn its three wheels to correspond with the color code on any composition-type resistor—the standard RMA range is automatically and accurately indicated. Readings are direct... no cumbersome calculations! Or, turn the wheels to indicate any desired standard range, and you are immediately shown the correct color coding.

The RESIST-O-GUIDE is convenient and accurate—and varnished for durability. To get the RESIST-O-GUIDE contact your IRC distributor—it's not sold elsewhere.

THE  
*Resist-O-Guide*  
 10¢ at all IRC Distributors



**INTERNATIONAL RESISTANCE CO.**  
 401 N. BROAD ST., PHILADELPHIA 8, PA.  
 Canadian Licensee: International Resistance Co., Ltd., Toronto

# WHY THE TUBE SHORTAGE?

## *The present tube situation is one of great complexity*

**D**URING the past few months we have received a number of communications from radio dealers and service people. The following is a good example:

*Editor, RADIO-CRAFT:*

"If I were running a radio magazine serving the Serviceman, I would try to find out WHY the tube situation today is worse than it was during the war and inform the serviceman and the public just what IS the truth.

"It would seem to me the customer, who supports the radio industry, should have first call on tubes, not the factory, who would only sell them more radios when they have enough and all they need is tubes to make them work.

"When so-called radio tube companies advertise batteries, pilot lamps, etc., and avoid mentioning RADIO TUBES which is their main article, I KNOW something is rotten. We don't WANT pilot lamps, batteries, what we NEED IS TUBES! TUBES!! TUBES!!!

"They were d—n glad to sell us tubes in prewar years when the factories gave them next to nothing for them, but now, there must be a black market, with greasing, etc., to get the tubes that the public needs.

"They promised great things when the war was over, or is it?? Is the army still taking most of the tubes? Is that what they feed the men? Every ad you see has something else, but no TUBES."

CHAMBERS & SON,  
RADIO REPAIRS,  
Upper Darby, Pa.

RADIO-CRAFT contacted a number of radio tube manufacturers, among them the largest in this country, and has gathered some information on the subject. This may serve to explain the present acute shortage and give an indication when it may be relieved.

To begin with, *officially* the war is by no means over. Very large numbers of troops are still gathered in many former war theatres from Europe to the Pacific. The Army, Navy, and auxiliary forces still maintain in use for communication purposes a great deal of radio equipment. They still consume large quantities of radio tubes, be it for new and more modern equipment or for replacement purposes.

Then, too, new trainees are still being inducted

into the various services. Routinely they require large amounts of radio equipment. The Navy also still has a sizable portion of equipment afloat making it necessary to use practically all its shore radio installations. Naturally the military not only uses up millions of radio tubes, but also has priority on such matériel.

Strikes in many industries have slowed up many manufacturers — among them radio tube manufacturers. They have not as yet recovered from this slow-up, though the condition is being relieved slowly as this is written.

The complexities of modern radio tube manufacture is another reason given for the slow-down in tube production. Manufacturers have many divisions, or "units," which process different stages of production. Thus we have glass-blowing units, exhaust units, assembly units, etc. According to tube manufacturers contacted, present-day inefficiencies or shortage of certain supplies may cut output of a single unit as much as 20 percent, thus creating a bottleneck which may hold up other units which are not in themselves suffering from inefficiencies or scarcity of materials.

A rather large percentage of all labor employed in the production of radio tubes goes into the "mount." This term describes the already assembled part of the tube, comprising cathode, plate grid, etc., which is put together before the envelope is put on and the tube is ready for exhausting and sealing.

To obtain sufficient labor, during the war, it was necessary for tube manufacturers to establish so-called "feeder plants" in localities where quantities of skilled labor was available. These plants in many cases were relatively distant from the main factories, and their establishment and operation increased costs to a point that — now the war is at least unofficially over and the manufacturer has to face O.P.A. price regulations and a competitive market — consideration had to be given to closing them.

Let us now turn to the present receiving tube market, as compared to the prewar market. Prior to the shut-down of radio receiver production in 1941, the radio industry used approximately 100 million tubes for equipping their new radio receivers.

At that time the average requirement per set was 5½ tubes. The replacement market in prewar years averaged one out

(Continued on page 652)

# RADIO-ELECTRONICS

## Items Interesting

**A METAL LENS** which focusses radio waves as a glass lens focusses light is expected to fill an important role in microwave relay systems. Similar units, developed secretly for military use, distinguished themselves in comparison with older types of radio wave directors.

The new lens was designed and developed by Dr. Winston E. Kock and his associates of Bell Telephone Laboratories' technical staff.

It operates on a principle roughly akin to that of a simple convex magnifying glass. The action of the glass is to delay the advancing wavefront by an

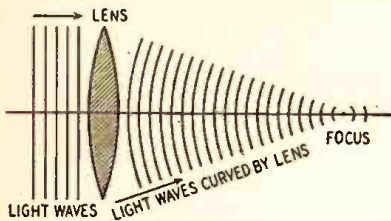

amount that is greatest at the center of the lens, where the glass is thickest, and least at the tapered periphery. As a result, the wavefront is reformed and headed so as to converge toward a point. This change in the velocity of a wavefront is a fundamental principle of all lenses.

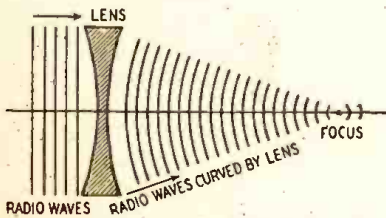

Since radio waves are of the same electromagnetic nature as light waves, it has been known theoretically for

some time that radio lenses on this principle might be built. Previous to the advent of microwaves, there was an insuperable obstacle in the very much greater length of radio waves, which in the commercial broadcasting band range from an eighth to a third of a mile. For a lens to be effective, it should have a diameter of at least several times the wavelength. This would have meant a lens almost a mile wide.

It was in pondering this problem that Dr. Kock thought back to waveguides, those hollow tubes which one of his colleagues had devised some years earlier to conduct microwaves and which, in war, were to play so vital a role in supplying a physical channel for radar signals.

It was known that radio waves undergo a speeding up, or increase in wavefront velocity, when they pass along such a tube or between metal plates and that the total advance of the wavefront could be fixed by controlling the length and contour of the plates and the distance between them.

It occurred to Dr. Kock that an array of metal plates could be designed to focus radio waves just as effectively as a solid lens might focus them if due regard were given to the fact that the edges of the wavefront would be advanced rather than retarded in transit. Such a structure would also be easier to build, move and maintain than an equivalent solid lens type.

(Continued on page 651)

**CAPACITOR** manufacturing methods may be revolutionized by a machine discovered in Germany and now brought to the United States for study, it was announced by the Department of Commerce last month.

This new machine, a development of the Robert Bosch concern, of Stuttgart, Germany, produces paper condensers without the conventional metal foil. The plates of the condenser are formed by coating the sides of the paper with a very thin layer of vaporized zinc. This machine may be expected to reduce the production costs of paper condensers by twenty percent.

**V-2 ROCKETS**, equipped with radio apparatus, will give scientists new information on our atmosphere up to a height of 100 miles, according to information released last month by the Army Ordnance Department. The rockets, taken from a captured German factory, will be equipped with apparatus to register and transmit information concerning temperature, pressure and other meteorological information, as well as reports (velocity, acceleration, altitude) on the progress of the rocket itself.

The V-2 is expected to reach a speed of 3500 miles per hour, and will land eighty-seven miles from the starting point. The flight will take seven minutes, and is expected to collect enough data in that time to keep a group of scientists busy for several weeks. The Army Ordnance Department expects to gain from it information on rocket flight which may be of great value in designing future aerial projectiles.

**RADIO-CONTROLLED** crewless airplanes will "watch" the atomic bomb tests over Bikini, the Navy Department stated last month. The planes, four in number, will fly at different levels into the turbulent air storms created by the blast.

They will carry devices to capture samples of the gases created by the blast and to record radio activity and other characteristics of the churning air mass.

Guide planes, bearing live crews, will fly 12 to 30 miles from the atom blast, thus being outside the danger area, the Navy Department reported.

**BRITISH TELEVISION** will resume war-caused interruption of almost seven years on the seventh of June at 3:00 pm, a British Broadcasting Co. notice announced last month.

Pre-war practices, including the 405-line standard will be used. Thus pre-war receivers can be put into action with no modification, the report stated.

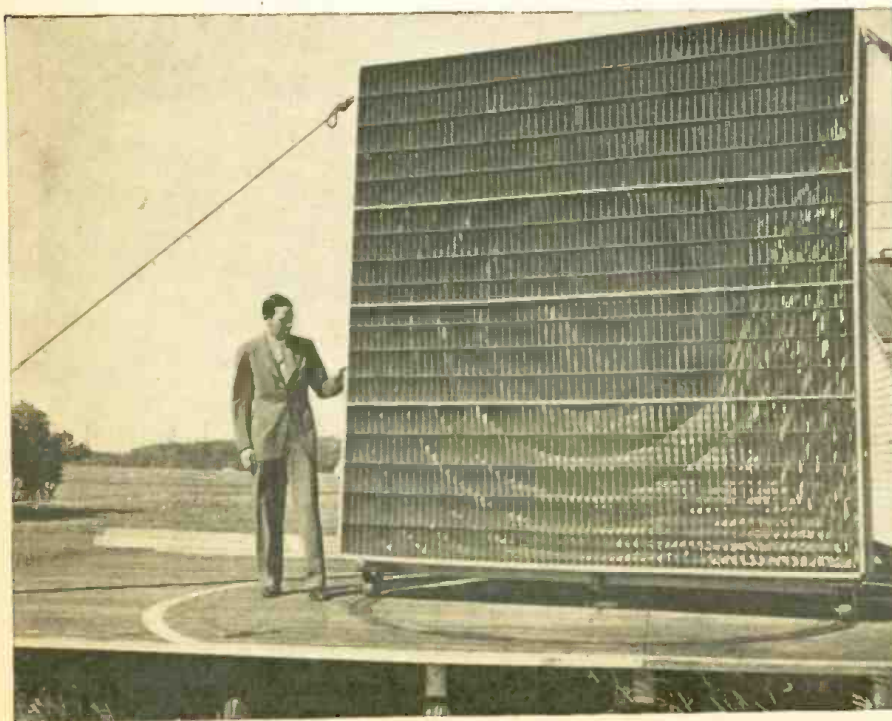

This large metal lens concentrates radio waves more sharply than can any other director.



# MONTHLY REVIEW

## to the Technician

**MORE FM** receivers were urged by the FCC, after a survey of manufacturers made last month. The eighty-four companies covered in the survey reported an expected output of 1,800,000 FM receivers for 1946. In addition, they expected to make converters and adapters numbering something less than 100,000, as well as 50,000 combination FM, television and broadcast sets.

Pointing out that applications were on hand for 834 FM stations, the FCC urged that manufacturers revise their production schedules to increase the number of FM sets.

**RADIO SET PRODUCTION** for 1946 will fall "far below" the FCC prediction of twenty million receivers, stated J. D. Secrest of the RMA publications bureau last month.

Calling the FCC report "a lot of wishful thinking," Secrest said the estimated volume for the first quarter of this year is only two and one-quarter million. While it is possible that production might hit two million sets a month by mid-summer, he added, the FCC figure definitely will not be reached, due largely to component shortages and an OPA bottleneck.

The Commission's estimate was nearly 50 percent higher than the peak pre-war year, 1941, when receiver output was 14 million.

**"SPY RADIOS"** picked up at various points in occupied Italy, were revealed last month to be ordinary radiosondes, released by American meteorological services and plainly marked as U. S. Government property.

A pint-size spy scare had been aroused before the true nature of the mysterious instruments was revealed, and at least two European powers were accused by opposing factions of undercover intervention in Italian politics.

The scare reached even to the United States, and reputable American papers pointed out solemnly that the transmitters were of the "tiny type suitable for agents inside enemy lines." The label "Notice to finder; this instrument belongs to the United States Government," according to the same source, "signified only that it is pretty certainly not Americans who are dropping the radios, as there could be no conceivable reason for the Americans or British to use that method to distribute any radio apparatus they wished to distribute in Italy."

From the description, the radios were very standard radiosonde apparatus, and apparently could not have been turned over to technical personnel for inspection, as the barometer and hygrometer, contained in each, as well as the highly special switching system, would have identified them immediately.

**COMMUNITY** radio broadcast towers may become the rule in the future, according to engineers of the Federal Telephone and Radio Corporation, who started construction of such a unit at Nutley, New Jersey, last month.

The Nutley tower will be experimental. It will house as many as twelve FM sending units on different channels, six color and four black-and-white television transmitters, six police radio networks serving as many different communities with signals, as well as experimental pulse - time - modulation transmitters for beamed-radio links to other cities miles away.

The tower will, its builders hope, become a center of experimental work on microwaves from which much of the services of tomorrow will spring. The waves from the 300-foot structure will run the gamut of the high frequencies from the "medium hundreds to the many thousands of megacycles."

Two strong arguments favor the community arrangement. Joint financing would make better facilities more feasible, and the tower could be put at the location giving the most effective coverage of the area served (ideal spots are not too plentiful in most communities).

**TELEVISION** links between Moscow and Leningrad and separate studios in the cities of Kiev and Sverdlovsk are planned for the near future, a report from Moscow announced last month. Soviet radio experts expect that by 1950 thousands of Russian sets will be receiving television in full natural colors.

Television broadcasts now are made twice a week to an area within thirty-five miles of Moscow. Daily broadcasts are expected to start this year. Clarity and reception have improved and by next year should equal the quality in the United States, the Television Center said. Only one-color broadcasts now are attempted, but equipment is being developed for colored showings.

**ELECTRONIC** night sight reduced the infiltration menace in the Pacific war theatre, it was revealed last month by R. H. Frye of the Electronic Laboratories, Indianapolis.

The device (known as a "snooper-scope") looks like an ordinary short telescope such as may be seen in various sighting devices, with an additional disc-shaped object mounted just below it. The disc is in reality a very powerful infra-red lamp and lens, projecting a beam of invisible "black light."

The infra-red rays, reflected from objects in their path like ordinary light, operate the receiving end of the instrument. Though this looks like an ordinary telescope, it is more like a television



The portable Snooperscope and power supply. A modified form of the instrument, called a Sniperscope, attaches directly to a carbine.

tube. Only the lens at the front of the tube is a real optical device. The reflected infra-red rays are picked up by this objective lens and focussed on the image tube, causing a photo-sensitive screen to emit electrons in direct proportion to the intensity of the invisible rays.

These electrons proceed down the tube, accelerated by high-voltage electrodes, and strike an ordinary fluorescent screen at the other end, causing it to glow and thereby producing a visible image which reproduces faithfully the details of the original scene. Thus the rays pass through three stages—beams first of infra-red "light," then of electrons, and finally of visible light—before reaching the eye of the beholder.

All power for the apparatus is supplied.

(Continued on page 651)

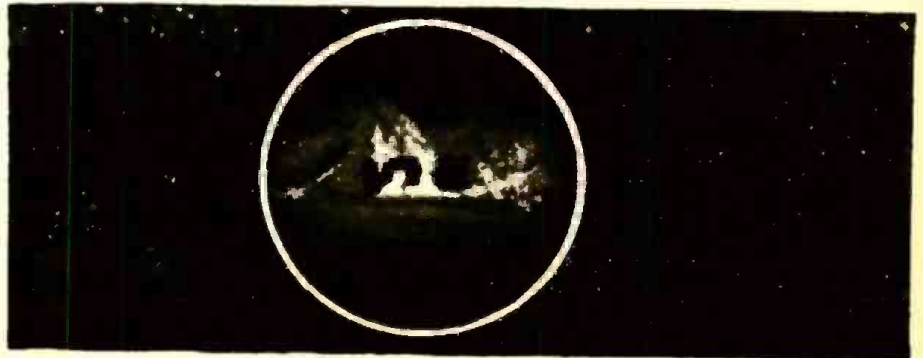

The figures coming out of the dugout are quite invisible to unaided night-adapted eyes.

# TELEVISION FOR TODAY

## Part I—Some Fundamental Principles

**A** KNOWLEDGE of fundamental radio principles is definitely essential to an understanding of television. The theory and operation of standard broadcast sound receivers is now well known. This does not imply that an automatic transition to modern television can be made, in spite of the number of similarities between the two systems. Many circuits are entirely new and different. It is the purpose of this series to help bridge the gap between the already well-known facts of radio as manifested in broadcast transmission and reception of today and the lesser-known features of tomorrow's television.

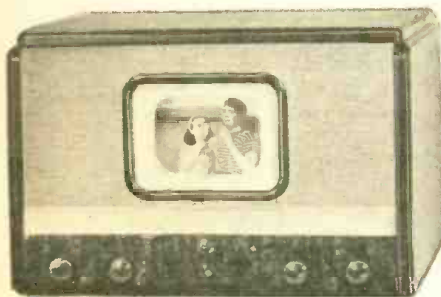

Courtesy Belmont Radio Corporation  
Postwar television receiver with 7-inch tube.

Before we attempt any comparison of the two systems, let us determine briefly what components form a complete television system, from the transmitter at the broadcast station to the receiver in the home.

First, there is the scene to be televised. This scene must by some means be converted into an equivalent electrical pattern, thus rendering it suitable for transmission to our receiving antenna. In the sound transmitter, a microphone is the converter. In the television system we employ a camera tube. Within this tube the incident light

rays from the scene are brought to focus upon a photosensitive plate. The resulting physical actions produce a charge distribution on the plate surface that is suitable for conversion into electrical currents, known as the camera signals.

Second, there is the problem of how these electrical currents are to be utilized. As every photographer knows, a negative is nothing more than a collection of tiny silver compounded grains which have been acted upon by light. In the television camera, much of the same situation exists. The focused light has produced a change in each of the photosensitive globules deposited on its plate. Now we must dissect the image in order to transmit it. We could, if we wished, connect a complete transmitting circuit to each element (globule) and send the entire picture at one time. This would prove far too difficult. Much simpler in practice is the method whereby an electron beam scans across the image in a series of 525 horizontal lines. These follow in a predesigned order and are reconstructed in identical manner at the receiver. Thus the image is broken down at the transmitter, sent in fragments and then reassembled at the receiver.

This method of transmission poses yet another problem, that of *synchronization*. As long as we are sending the image in a series of lines, some form of identification must be inserted, along with the signal, to indicate to the receiver just where one line ends and the next begins. Failure to keep both the transmitter and the receiver in step would render it impossible to reproduce an identical image at the receiver. Synchronization is accomplished by inserting a series of pulses into the television signal at the end of each horizontal line. We have one set of pulses for the end of each horizontal line and



Milton S. Kiver was born in New York on November 5, 1918, just a trifle too late to make the first World War. Became interested in radio as a hobby and as a result majored in Physics and Mathematics in college. After graduation and several years of odd jobs in radio, became associate instructor in radio engineering for the Army Air Forces. From here to Illinois Institute of Technology and thence to the Navy for 27 months in the radar program. At present on the engineering staff of American Television Laboratories of Chicago.

Mr. Kiver is author of numerous articles in technical publications and of two books, "UHF Radio Simplified" and "Television Simplified."

another set of pulses, known as the vertical synchronization pulses, to bring the electron scanning beam back to the top of the image after the bottom line has been traced out.

During the short intervals of time that the synchronization pulses are notifying the receiver circuits to move the beam into position for the following information, a *blanking pulse* is also active. Its purpose is to prevent the electron beam from reaching the viewing screen. Without this precaution, we would actually see a trace as the beam moved from the right-hand part of the image to the left-hand side for the start of the next line. Since no signal is being

(Continued on page 638)

Fig. 1—The complete video signal for one line. The high points are synchronizing pulses. All values are reversed at the grid of the cathode-ray viewing tube.

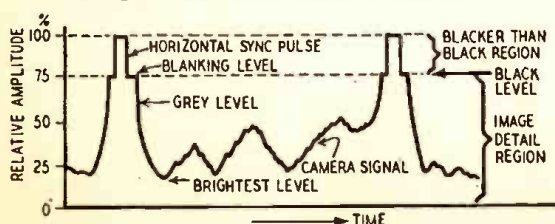
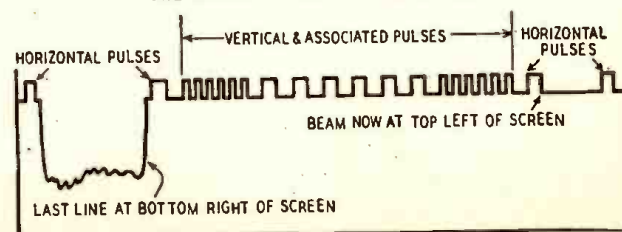

Fig. 2—The vertical pulse contains horizontal pulse components, as shown. The whole pulse is in the blacker-than-black region, and makes no trace on the screen.



# FM CARRIER STABILIZATION

## Part II—Western Electric, Westinghouse, RCA Circuits

THE previous article described the need for control of the center frequency of an FM transmitter and showed that direct crystal control is not possible. Several commercial control systems were discussed. Others are described below.

A small but effective unit is responsible for carrier control in Western Electric FM transmitters. The heart of the system is a small induction motor which controls the tuning condenser in the plate circuit of the oscillator. The latter frequency is approximately 6 mc, which is multiplied by 16 (doubled four times) in succeeding stages to reach the new FM broadcast band of approximately 100 mc.

A portion of the 6 mc oscillator output is fed to frequency dividers which reduce the frequency by a factor of 1024 and therefore produce a frequency between 5377 and 6586 cycles, depending upon the assigned carrier. A crystal oscillator, operating on this same frequency, is also used.

These two frequencies are applied to the stator windings of an induction motor such that the beat frequency between them acts to turn the rotor. Thus, when the station is exactly on its correct frequency the motor is stationary, but if there is a drift in either direction, the rotor experiences a torque in the corresponding direction. The motor can take care of a change of about 50 cycles per second, equivalent to about 50 kc per second at the oscillator.

Because of its inertia, the rotor is not actuated by the relatively rapid modulation changes, but the more gradual oscillator drifts are promptly corrected.

### WESTINGHOUSE CIRCUIT

These circuits are based on methods of pulse generation and control which were developed during the war in connection with radar. As in other systems a crystal-controlled reference frequency is used as the standard with which the signal frequency is compared. The mas-

ter oscillator frequency is 1/9 that of the assigned carrier. The reference crystal frequency, temperature controlled, is equal to one-half of the m.o. frequency and its second harmonic is therefore used for comparison.

The output of the reference frequency  $F_R$  is divided into two parts. One is advanced in phase by  $45^\circ$  and the other retarded by the same angle. Each is mixed with FM oscillator output ( $F_s$ ) in a separate 6SA7 tube. (Fig. 1). As a result, the beat frequency output of each mixer tube is displaced by  $90^\circ$  from the other. When the signal frequency ( $F_s$ ) is the greater the output at B leads A by  $90^\circ$  and it lags by  $90^\circ$  when the crystal frequency is greater. When the two are equal there is no beat frequency. (See Fig. 2.)

The output of A actuates a direct-coupled multivibrator (Fig. 3), which amplifies and flattens the peaks of the sine waves. Because the tubes are greatly overloaded, the flat portion of the square waves is reached at about the time the sine wave passes through zero. The square waves are transmitted through an integrating R-C circuit which limits the horizontal or constant portions but passes the sharp changes in voltage. As a result, voltage pulses appear across each resistance with points D and E out of phase. The pulses are drawn for two conditions:  $F_s > F_R$  and for  $F_s < F_R$ .

A 6H6 pulse detector (Fig. 4-a), now receives the pulses and also the sine wave output of mixer B. The tube is biased just beyond the peak value of the wave. As shown in Fig. 4-b, the pulses add or subtract from the sine waves, depending upon whether the FM oscillator frequency drifts higher or lower and upon which diode plate the measurement is

made. Because of the bias voltage there will be either no output at all or merely the pulse output, depending upon whether they oppose or aid. Note that the output of B appears in the same phase at F and G.

The next stage consists of four charging rectifiers designed to charge

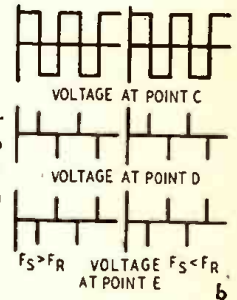
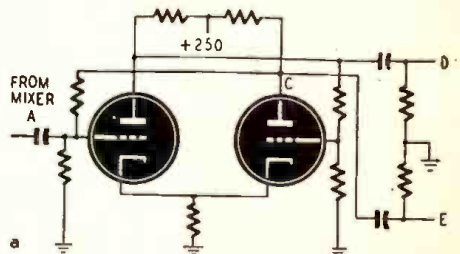

Fig. 3—The multivibrator produces pulses, to be combined with the output from Mixer B in the rectifier stage.

or discharge the condenser C according to polarity of the pulse input. These rectifiers are shown in Fig. 5-a and also at the lower right of Fig. 6, the complete schematic, including circuit parts as is shown in Figs. 1 to 5. Since current can pass through the input condensers (Continued on following page)

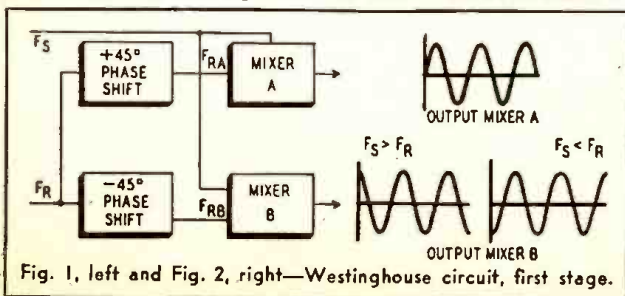
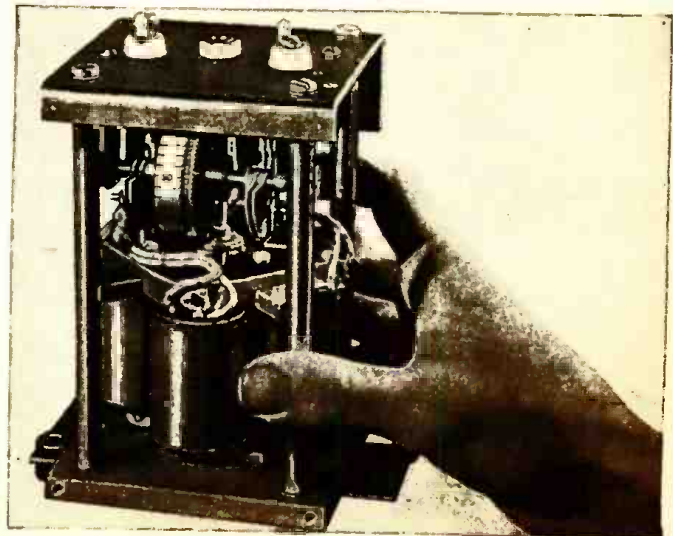

Fig. 1, left and Fig. 2, right—Westinghouse circuit, first stage.



This little motor is the heart of the Western Electric stabilizer.

in either direction because of the full-wave connection, the rise in the pulse will produce current in one direction, and the corresponding fall reverses the current. Results shown in Fig. 5-b are for a condition in which the FM oscillator is first lower than the crystal frequency and then drifts to a higher value.

Referring back to Fig. 4, it is seen that the voltage pulses at H are responsible for current at K, but that as the frequency drifts upwards this current disappears and instead current

flows at L, due to voltage pulses at J (in Fig. 5).

Current through M and N can only flow in one direction, evidently upward in each. Therefore current at M must raise the potential across C. Likewise current at N lowers the condenser voltage. These are shown in Fig. 5. Since there is no bleeder resistance across C (Fig. 6) its voltage is governed only by the frequency difference between the two oscillators.

The voltage across C changes the grid voltage of a 6SL7 cathode follower in such a way that the bias voltage for the modulator control tube is varied. Changing the grid voltage (of the 6SL7) thus changes the current through the control tube (Fig. 7), and this affects the equivalent resistance

of the two 6H6 modulator tubes. Each diode shown is really two sections of one tube connected in parallel. The resistance variation changes the frequency of the oscillator tubes in a direction to correct for their drift.

This system eliminates all moving or critical parts. Except for the oscillator tank it does not contain any tuned circuits. Even tube aging does not affect the operation, since they are used merely as electronic switches and do not operate on the critical portion of their characteristics. Carrier deviation is held to a maximum of  $\pm 1000$  cycles, far below that permitted.

#### RCA "DIRECT" FM

Some of the principles previously described are used here, but under different conditions. For example, a two-phase motor controls the tuning and a reference crystal oscillator is also part of the circuit. A two-phase output is obtained from the latter by means of two balanced modulators.

The FM modulated oscillator tube is a 6V6 operating within the range 4.5-6.0 mc, which is divided by 240 in four stages. These stages use the so-called lock-in circuit developed by Beers, as shown in Fig. 8. A tuned circuit must be used but it results in a much better wave-form than that of a multivibrator and therefore does not require filtering. The lock-in range holds for frequencies within  $\pm 5$  percent of the desired subharmonic. Tuning is accomplished by an iron slug within the coil.

The reference crystal oscillator operates within the convenient range 94-125 kc, and a divider (by 5) brings it down to the same frequency as obtained from the FM oscillator. The divided crystal frequency is now (Fig. 9), applied across two phasing circuits which causes the outputs to differ by  $90^\circ$ , and these together with the divided FM oscillator frequency are connected across two balanced modulators. As in the previously described system, the output will be two-phase current with a  $90^\circ$  difference. Whether one phase leads or lags the other is determined by whether the FM oscillator is less or greater than the correct frequency. Thus, the motor ex-

periences a torque in the proper direction and its magnitude depends upon the correction to be made.

The induction motor can start with as high as 1000 cycles per second input. To eliminate friction and lost motion, the tuning condenser is mounted directly on the shaft. At no time is the rotor required to turn over more than  $\pm 45^\circ$  to provide full frequency correction. The windings are of sufficiently high impedance to be operated directly in the plate circuits of the four 1614 type (equivalent to 6L6) motor (modulator) tubes. Therefore all frequencies down to d.c. may be transmitted.

Frequency modulation is accomplished by the direct system using a reactance

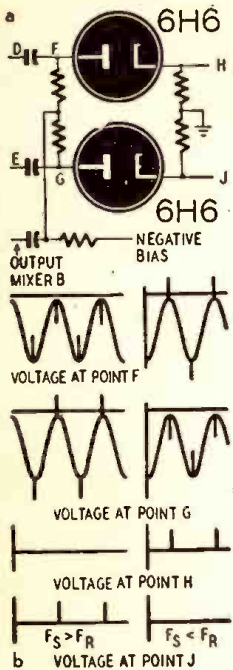

Fig. 4—The rectifier.

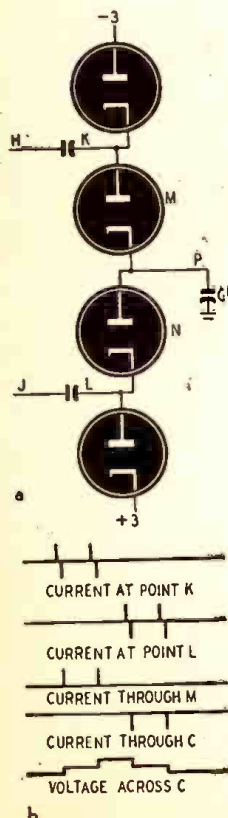

Fig. 5 (above) and Fig. 6—Condenser C in Fig 5 is the one so marked in the 6H6 output to the 6SL7 grids (bottom row of tubes, Fig. 6).

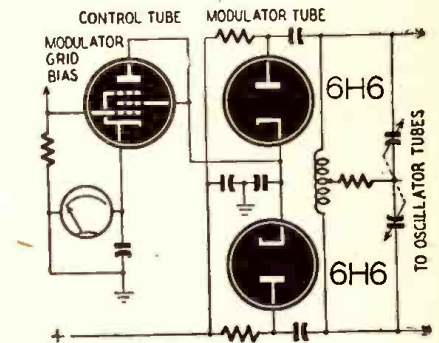

Fig. 7—Phased output to final control tube.

tube. This method is simple and is well known and used by amateur FM stations. Its principle is as follows. The reactance tube is connected in parallel with the oscillator tank, with a  $90^\circ$

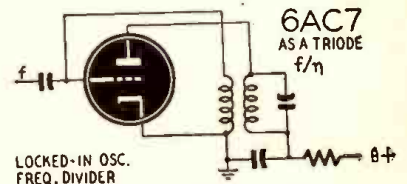
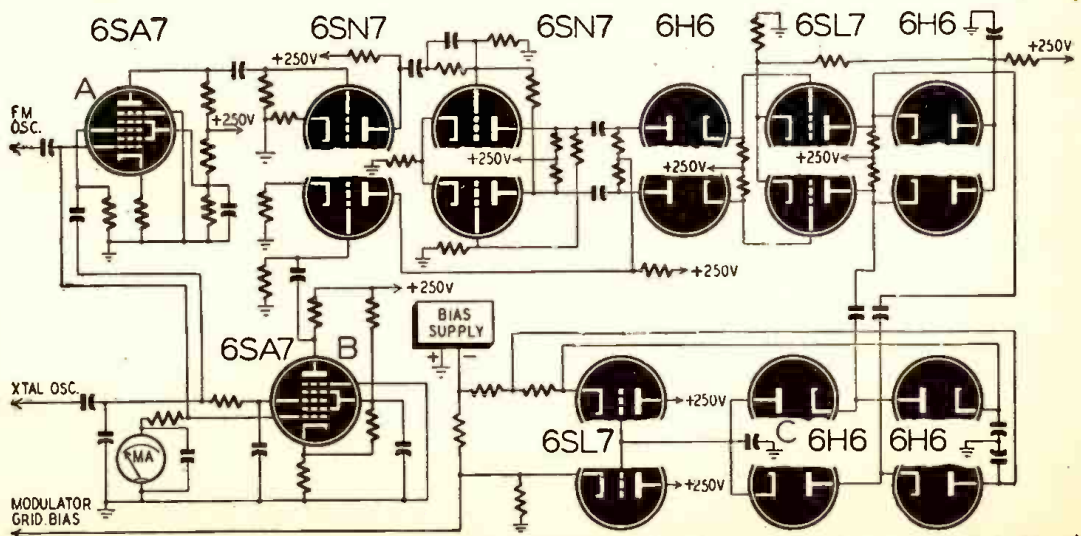

Fig. 8—Circuit of lock-in frequency divider.

phase shift applied between its plate and grid. (Fig. 10.) As an example, a condenser may be used between plate and grid and a resistance between grid and cathode. If the magnitude of the latter may be neglected in comparison with

(Continued on page 637)



# THREE-CHANNEL AMPLIFIER

## A 15-Watt Unit with Individual Control of Each Channel

**W**E must never lose sight of the fact, in considering the construction of any sound apparatus, such as an amplifier of frequencies in the musical range, that it is the ear which judges the excellence of the instrument—absolutely without appeal. It is therefore indispensable to examine the conditions under which that organ functions, to adapt our sound equipment to it in the best possible manner.

The sensitivity of the ear varies as a function both of the frequency and intensity of the sound. If we consider very weak intensities, the ear hears medium register sounds much better than basses or high-frequency notes. At medium intensities, all the frequencies are heard equally well, and for very loud sounds, the basses and highs are perceived with greatest intensity.

### THE CURVE OF AN AMPLIFIER

It appears from the considerations above, that the principle that leads to giving an amplifier a linear frequency curve is completely illogical. It is necessary to so design the equipment that the listener will hear the sounds reproduced under conditions which approach as close as possible those of listening directly to the sound source itself.

Let us take, for example, the case of a symphonic orchestra. If the listener is in his orchestra seat in the auditorium where the orchestra plays, he hears the music at such an intensity that his ear perceives it with the same relative sensitivity over the whole range of musical frequencies. But if he hears the same program over his radio or from records, through a loud speaker in his own living-room or bedroom, it is obvious that that intensity will not be as great—the size of a private room being considerably smaller than that of a concert hall. If he turns up the volume control to get the same sound level (which is possible) the neighbors with different musical tastes—or those who desire the sleep of the just—will not be slow in protesting energetically. He will therefore regulate the volume to a sound level rather on the weak side.

It is then that the ear registers its discontent with this "sound rationing" by refusing, as just pointed out, to hear the low and high notes with the same force as the frequencies in the middle of the audible spectrum. But, if our critical listener is clever and especially if he constructs his own amplifier, he will design it with such a response curve that it overamplifies the highs and the basses relative to the medium frequen-

cies, to exactly the same extent as the ear tends to weaken them. He thus does his own ears a good turn, at the same time restoring the musical equilibrium.

### THE DESIRED AIM

To establish the response curve of which we have just spoken, it is necessary to know that of the ear. That curve has been traced by the physicians and physiologists, who have established it by the average of several thousands of individual cases.

Since the amplifier is destined for the pleasure of one sole listener, it may well happen that the particular ear in question will be very different from the "average ear." Therefore it is infinitely preferable to permit the user to adapt

the amplifier response to his own needs and tastes.

It is with this idea that the amplifier here described was conceived. It has three channels, one for each band of frequencies: bass, medium and high, the amplifier for each channel being controllable independently of the others.

### DESIGN AND CONSTRUCTION

We shall scrupulously avoid the hackneyed description of: "the tube A, plate of which is coupled to the grid of tube B through the blocking condenser C, etc.," refusing to consider the reader so benighted that it is necessary to point out that which he can see clearly in the accompanying schematic drawing.

(Continued on page 642)

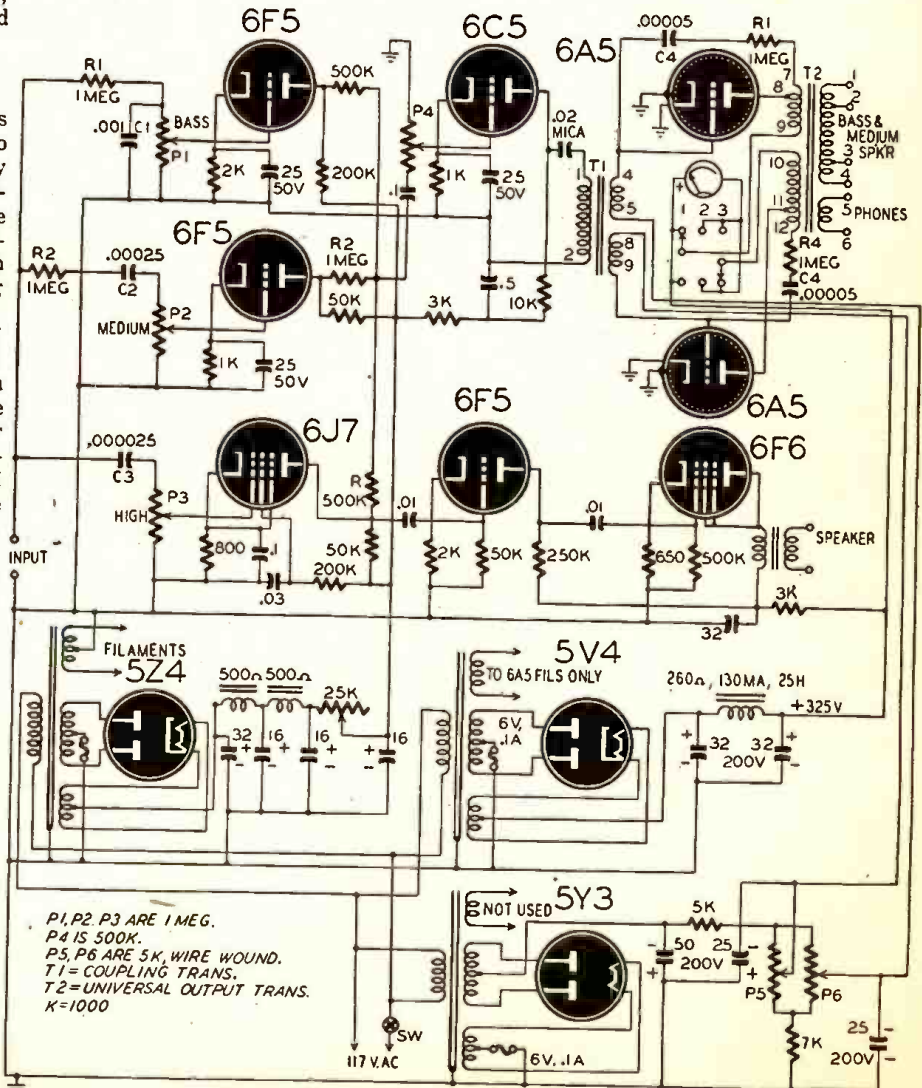

P1, P2, P3 ARE 1 MEG.  
 P4 IS 500K.  
 P5, P6 ARE 5K WIRE WOUND.  
 T1 = COUPLING TRANS.  
 T2 = UNIVERSAL OUTPUT TRANS.  
 K = 1000

Many original features are to be found in this French high-fidelity, fixed-bias amplifier.

# HIGH-POWER U.H.F. TUBE

## Triode Penetrates Far Into the High-Frequency Spectrum

**C**OLOR television owes much to wartime radar, for the high-frequency triodes represented by the 6C22 were developed originally as radar transmitter tubes. The 6C22 itself is a modification for continuous-wave operation of an older radar tube known as the L600E. This tube was capable of delivering pulses up to a peak power of 25 kw, but was not altogether suitable for non-pulsing applications. The 6C22 was then developed by engineers of the Federal Telecommunications Laboratories for continuous duty. Working as an r.f. amplifier, it is capable of power outputs of 600 watts at frequencies up to 600 mc.

The tube is of remarkably small size for its output, as will be seen from the cover picture and the illustration on this page. Such economy of dimension is necessary for operating at the high frequencies for which it is employed. Internal construction may be seen in Photo A. The squirrel-cage structure in the left-hand portion is the grid. It consists of thirty-two .008-inch diameter wires spot-welded to and supported by a low-inductance cone, which is attached to the grid ring, seen just above the tube base. The anode is made from a solid copper cylinder. In one end is a cavity into which the grid fits; the other or water-jacket end is slotted. Spacing be-

tween the grid and anode is very close—this being another feature necessitated by the high frequency at which the tube is to work.

The filament of a high-power, ultra-high-frequency tube presents special problems. Due to transit-time effects, not all the electrons emitted by the filament or cathode when the grid is positive reach the anode. Many return to the cathode space-charge region. This causes a decrease in anode current and

CHARACTERISTICS, 6C22	
Filament	Thoriated Tungsten
Filament Volts	6.5
Filament Amperes	18
Amplification Factor	9
Mutual Conductance (ma/volt)	13
Maximum Anode Dissipation (Kilowatts)	2
Maximum Anode Volts	3,000
Maximum Grid Dissipation (Watts)	25
Capacitances $\mu\text{f}$ .	Cgp 6
	Cgf 7
	Cpf 0.4

power output. To increase the current, the cathode must emit a greater number of electrons to compensate for those which do not reach the anode. The required emission may be several times as great as in low-frequency applications where transit-time effects do not have to be considered.

The filament is therefore a thoriated tungsten wire of .025-inch diameter, coiled in a bifilar helix inside the grid assembly. It has an active emissive surface of three square centimeters. Spacing between grid and filament is held to a minimum.

Characteristics of the tube are shown in the table. Most of recent studies

on it have been made at 600 mc. At this frequency, in a neutralized inverted amplifier circuit, with 1600 volts on the anode and a current of 0.65 ampere, the power output is in the order of 500 watts. A driving power of 190 watts is required.

### THE COLOR TRANSMITTER

The high-definition color television transmitter built for the Columbia Broadcasting System by Federal Telephone and Radio Corp. operates on a frequency of 490 mc. It can be modulated uniformly with all frequencies from zero to ten megacycles, and is the most powerful transmitter of this frequency and modulation bandwidth yet installed.

Four 6C22 tubes are used in the radio-frequency section of the transmitter and three in the video-frequency modulator. The r.f. section starts with a 6V6-GT crystal-driven at 6.805 mc, and is followed by a number of conventional stages which multiply the frequency to 122.5 mc and amplify the power to 120 watts. This is followed by a 6C22 in a co-axial circuit operating as a frequency doubler, which delivers 250 watts at 245 mc. The co-axial amplifier is shown in Photo B. The anode circuit is a quarter-wave line shorted at the end farthest from the tube. Tuning is by a movable piston.

Another 6C22 doubles from 245 to the final frequency of 490 mc. The stage operates as a grounded-grid amplifier, and delivers 300 watts to a 6C22 neutralized amplifier, which also operates as a grounded-grid stage, and delivers approximately 700 watts at 490 mc. This is considerably more than is needed to drive the final to its full peak power of 1 kilowatt, but the excess power is dissipated in a damping resistor attached to the coupling line between the driver stage and the final modulated amplifier. This resistor acts to maintain constant output voltage from the driver stage in spite of the output stage's changing load as its bias is varied through the modulation cycle. This improves the linearity of the modulation characteristic and reduces somewhat the voltage required from the modulator stage.

The final, or modulated amplifier stage, also uses a 6C22 in a neutralized, grounded-grid circuit. With a drive of 350 watts it will deliver any output from zero to one kilowatt peak. The rated average output of the stage is 600 watts.

### THE VIDEO AMPLIFIER

An interesting feature of the video  
(Continued on page 640)

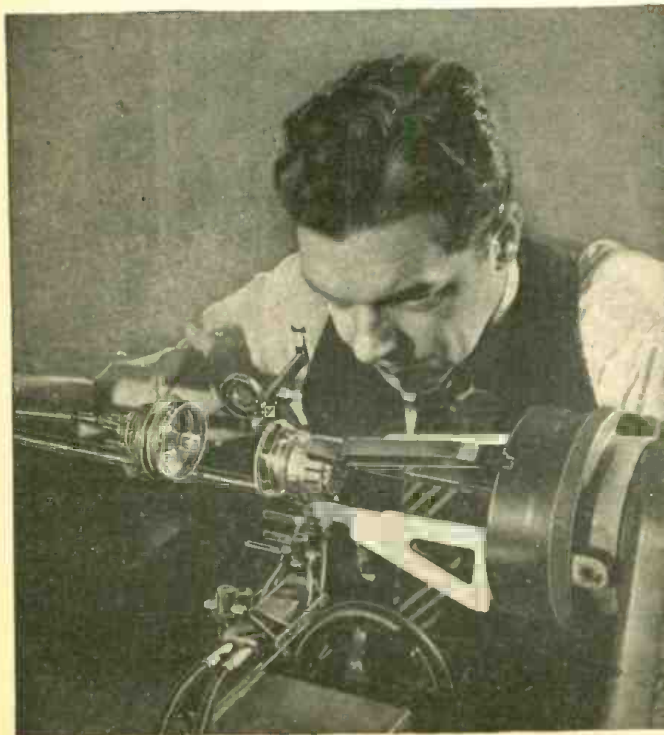

Photo A—The portion at right is the anode end. The grid is visible in the other half. Operator is aligning the tube elements before the sealing off.

# NOMOGRAPH CONSTRUCTION

## Part I—Nomograph for Current, Voltage and Resistance.

**A** NOMOGRAM (Greek: A new written down) is a chart made up of a number of lines calibrated to represent quantities in the problems to be solved. A straight edge is laid across two of the lines. The answer to the problem is found where it intersects a third line. Most of the commonest radio problems can be put into nomograph form, hence this type of chart is one of the most useful to radiomen.

This principle of the nomograph is simplicity itself. Fig. 1 shows a typical one, for adding figures from 1 to 10. The outside lines which represent the numbers to be added, may be 10 inches long, divided into equal parts (inches). The totals are found on a line drawn midway between the two.

To calibrate the center line, lay a ruler across the tops and bottoms of the two outside ones. Because 0 plus 0 = 0, the base of the center line is 0. At the top, 10 plus 10 = 20, and the line is so marked. Dividing the center line equally gives us 20 divisions spaced one-half inch apart. If a ruler is now placed across the two 5's on the outside lines, the sum 10 will be read on the center one. Try 5 plus 8 or 9 plus 1.

The addition nomograph may be mildly interesting. It is hardly useful—it is easier to do the additions mentally than to use the chart. The nomogram becomes valuable when applied to equations like

$$f = \frac{1}{6.28 \sqrt{LC}}$$

Such application is possible because multiplication and division can be transformed into addition and subtraction by means of logarithms.

Most radiomen understand logarithms. To those who do not, it is enough to say they are numbers so proportioned to ordinary numbers that the sum of the logarithms of any two numbers is equal to the logarithm of their product. For example, adding the logarithm of 5 to the logarithm of 6 gives the logarithm of 30. If we construct a chart like that of Fig. 1, using the logarithms of numbers from 1 to 10, we have a nomogram that can multiply.

### CONSTRUCTION OF NOMOGRAMS

Nomograms for all radio uses can be constructed with the help of a small supply of logarithmic cross-section paper, which can be bought at almost any stationery or draftsman's supply house. It is well to get a few sheets of "1 cycle X 10 divisions per inch" as well as a smaller number of 2-cycle and 3-cycle sheets (also 10 divisions per inch). Some tracing paper completes the outfit. Lacking logarithmic paper, a cheap slide-rule may be pressed into service. (The slide-rule is a perfect example of a logarithmically divided scale.)

Simplest of all multiplication nomograms is the product of two whole numbers—the logarithmic equivalent of Fig. 1. A chart for the common radio equation  $IR = E$  (Ohm's Law) is set up in Fig. 2. The easiest way to construct it is to fasten a piece of tracing paper over one of the 1-cycle log sheets and trace each of its vertical border lines. You will then have two lines about 10 inches high and 7 inches apart. Draw the base-line and erect on it a vertical center line half-way between the other two. Number your two outside lines according to the scale beneath the tracing paper. Mark the two outside lines I and R, and the center line E. ( $I \times R = E$ ).

Next step is to calibrate the center line. The bottom number on each outside scale is 1. Therefore the center scale at the base line is  $1 \times 1 = 1$ . The top of the center line is  $10 \times 10$ , or 100. Insert a 2-cycle sheet under the tracing paper, and line the base lines up with each other. You will find the 1 and 100 in

the correct positions, and can fill in the other divisions by tracing.

With this chart, the current through or voltage across any resistor between 1 to 10 ohms or 1 to 10 amperes and 1 to 100 volts can be calibrated.

### A PRACTICAL CHART

Our nomogram still seems to be of little use—the range is altogether too limited, and these simple problems are easier done in the head. It is not altogether useless, though its main purpose is to show how a nomogram works, before introducing more complicated ones. Its range can be extended by multiplying or dividing either of the factors I or R by any number (most conveniently 10) and doing the same with the center scale. Or one outside scale can be multiplied by and the other divided by the same number, leaving the center scale unchanged.

One of the great advantages of the nomograph is direct reading, so such tricks are not worth while. We can make a satisfactory chart by extending the two outside scales. Let us make one with the I and R scales on 2-cycle paper,

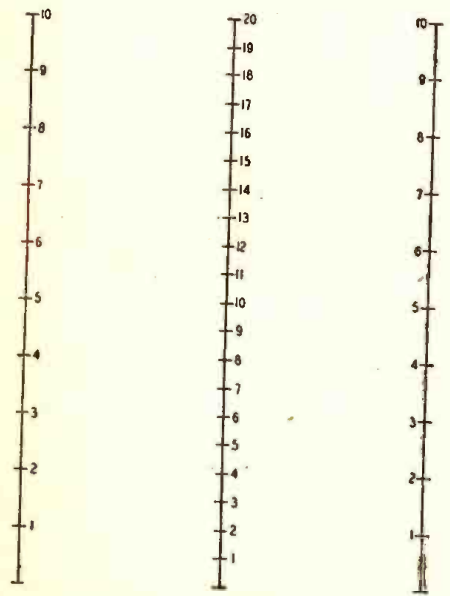

Fig. 1—The fundamental type of nomogram.

The reader will find it very helpful to actually construct such a nomogram. The important point to note is that the center line has twice as many divisions as the two outside ones. That is why their sum is found on it.

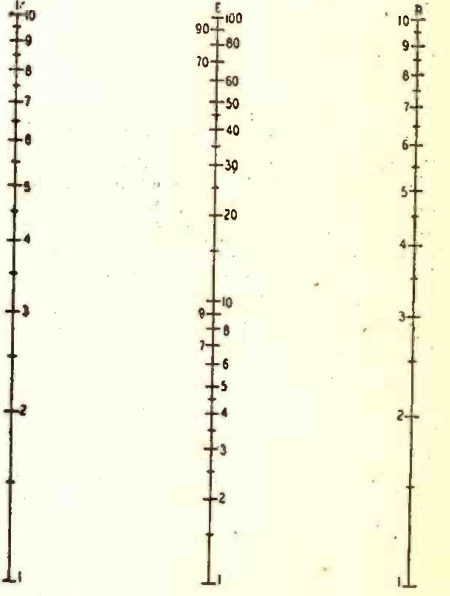

Fig. 2—Most nomograms are forms of this one.

giving them a range of 100 to 1 instead of 10 to 1. We can further increase the range by using two sets of figures for each I and R scale, giving us in effect two nomograms on the same sheet of paper.

(Continued on page 629)

# BETTER BROADCAST TUNER

## Companion to the Hi-Fi Amplifier Described in April

FOR persons who live within forty miles or so of a broadcasting station a TRF tuner is entirely adequate and has some advantages, particularly in large metropolitan areas where there are more than three stations. For high-fidelity reception, it is essential that our tuner not cut sidebands, or, that is, not have too high selectivity. As the standard AM broadcast stations generally operate so as to limit their band width to 10 kilocycles, it is necessary to provide a tuner with a response characteristic which has a flat top ten kilocycles wide. This can be done well with a superheterodyne, but

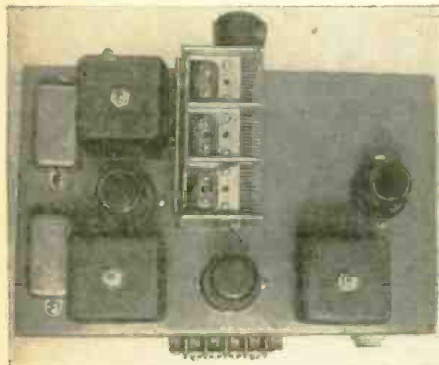

Photo A—Top view of the high-fidelity tuner. requires special intermediate frequency transformers and a complex circuit. A simple three-tube tuned radio frequency receiver can be built with a reasonably flat 10-kilocycle band width for a small fraction of the cost of the super. The TRF tuner will have a lower noise level, as it contains less tubes. It is also much easier to align. All that is necessary is to have a screwdriver and a station. The heart of this tuner is the coils. They should be of the shielded type.

Iron-core coils have the advantage of being tunable, so that the inductance of the coil may be varied to suit the particular variable condenser that you have.

The condenser is a three-gang unit, and should have trimmer condensers mounted on it. If not, three auxiliary compression-type condensers that have a capacity of about 70 micromicrofarads should be provided. All else we need are three octal tube sockets, a few resistors and condensers and a chassis. The chassis may be bent from steel or aluminum.

The layout shown in Photos A and B worked out very well. However, it can be changed somewhat if the shape of your chassis is different. The important thing is to keep the grid leads from the tube to the condenser and coil, short,

and as far away from the other grid leads as possible, or oscillation will result. These leads should also be kept close to the chassis, to keep down stray coupling. The parts in the author's model were mounted on a resistor board, which makes for a very neat arrangement.

A simple resistor board can be made of a piece of bakelite, cut in an oblong shape as in Photo C. Holes are drilled and soldering lugs are bolted to the bakelite. Resistors are soldered between the lugs. Of course, the resistors can be hung on the tube socket pins if a resistor board is not used. A terminal strip is provided on the back for connection to a power source. It is assumed that any standard amplifier will stand the additional current drain, which is very light, being in

the order of 25 milliamperes. If the amplifier does not have a 6.3-volt filament supply, or if it is heavily loaded, a 1½-ampere 6.3-volt transformer may be mounted on the tuner. Note that the output is taken from a microphone

connector and should be run through shielded mike cable to the amplifier.

An audio volume control was not included as it is assumed that the builder's amplifier will have one. If one is used it would be connected as in Fig. 2. The circuit diagram is shown in Fig. 1. It will be noted that resistors are connected across the coils. This is to increase the band width by reducing the Q of the coils and making their tuning broader. An r.f. gain control is provided

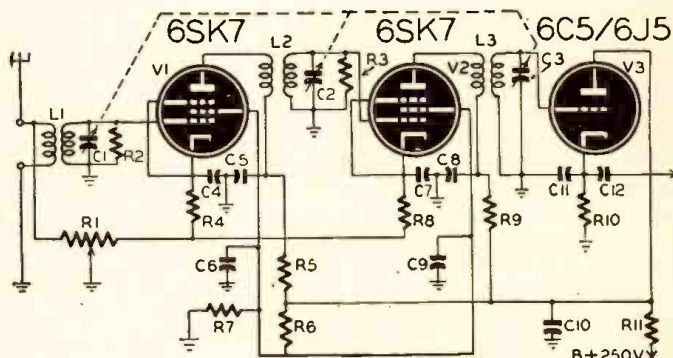

Fig. 1—The tuner is a 3-tube TRF with infinite-impedance detector.

ed as a sensitivity control. It has several functions. First, it allows the tuner sensitivity to be reduced when receiving a powerful local signal, which might overload the first tube's grid and cause

(Continued on page 636)

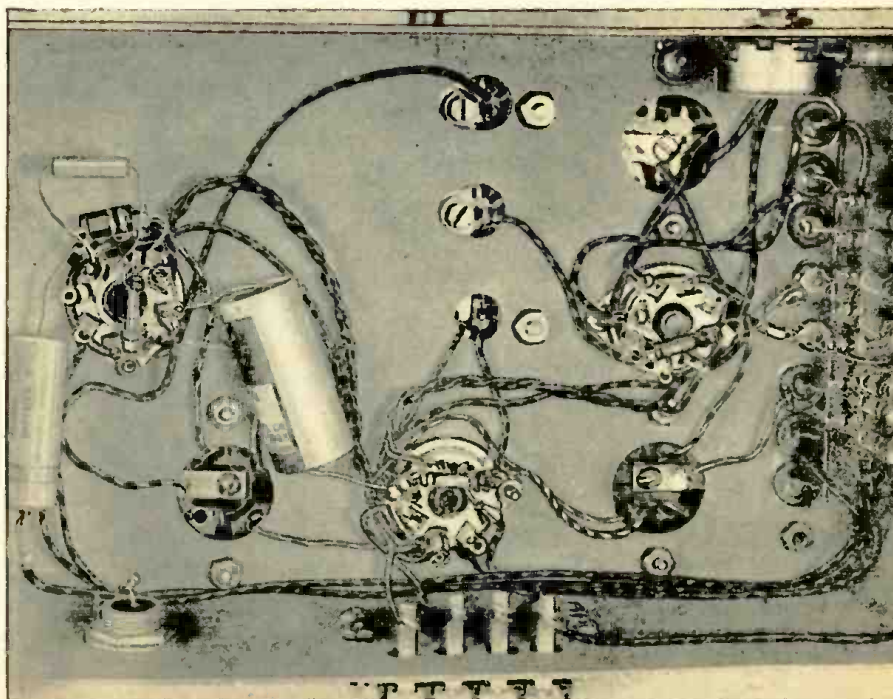

Photo B—Under-chassis wiring is simple and appearance is improved by the resistor board.





The average distance covered by this station is 30 miles when amplitude modulated and operated from a moving vehicle equipped with a 15-foot whip antenna. The range is more than doubled when using c. w. Under proper conditions, several hundred miles may be covered when operating from a fixed position with a quarter-wave antenna. These figures were determined when operating on frequencies between 3 and 4 mc.

The block diagram, Fig. 1, shows the relationship between the various parts of the transmitter and receiver.

### THE CIRCUITS

The receiver uses a 6K7 r.f. amplifier, 6K8 crystal oscillator-mixer, 6K7 i.f.

6L6 in a Pierce oscillator circuit driving a 6L6-G power amplifier. The modulator of the transmitter uses a part of the receiver audio section. One section of the 6Z7 is the speech amplifier, driven by a single-button carbon mike, and drives the 6L6 as a modulator.

With the SEND-RECEIVE switch in the receive position, the antenna is connected to the grid circuit of the r.f. amplifier. The signal is amplified and fed to the hexode section of the 6K8. At this point, the input signal is mixed with the output of the crystal oscillator in the triode section of the tube. The 456-kc i.f. thus produced is amplified by the 6K7 i.f. amplifier and applied to the diodes of the 6R7. The diode load resistor is tapped to provide a.v.c. and

6L6 plate through a blocking condenser.

A portion of the rectified voltage of the second detector is applied to a 6N7 connected in a Dickert automatic noise limiter circuit. The switch for this circuit is combined with the a.v.c. switch to provide selective operation of either or both circuits.

When the PHONE-CW switch is in the cw position, plate voltage is applied to the b.f.o. triode of the second-audio-b.f.o. tube. The output of this oscillator is loosely coupled to the diodes of the 6Q7. A second section of this switch removes the modulation choke from the plate lead of the power amplifier.

The combined power requirements of the transmitter and receiver totalled over 170 ma at 350 volts. A vibrator type power supply was selected for this service because it is compact and more easily serviced during field operation than the dynamotor or genemotor types.

To satisfy the comparatively large current requirements, two "universal" power transformers were selected. These units are equipped with two primary windings, one of which operates from a six-volt battery through a vibrator; the other operates from a 117-volt a.c. line. Each of the transformers was wired with individual vibrators in the six-volt primary winding. The high-voltage output from the transformers is rectified by separate full-wave rectifiers and fed into a common condenser-input filter circuit. The heavy current drain made it necessary to use two 6X5 rectifier tubes with plates connected in parallel in each of the high voltage circuits. When connected as in Fig. 3, the unit supplies more than 250 ma at 350 volts.

Since the 117-volt a.c. winding was available, it was decided to adapt the set so that it could be operated from line voltages if the occasion demanded. During a.c. operation, it is necessary to remove the vibrators from the circuit to prevent possibility of being damaged. Switching from a.c. to d.c. is accomplished by using two separate power cords which terminate in 12-contact sockets. A 12-contact panel-mounting male plug is mounted on the chassis of the power unit. The sockets and plug are wired so that the tube filaments are connected across the d.c. line when battery power is being used. When the set is being operated from 117-volt a.c. supplies, the a.c. socket is connected to the plug and the vibrator leads are opened so that no a.c. will circulate through the vibrators. The a.c.-socket also switches the tube filaments so that they operate from the transformer filament windings.

A five-prong tube socket is mounted  
(Continued on page 650)

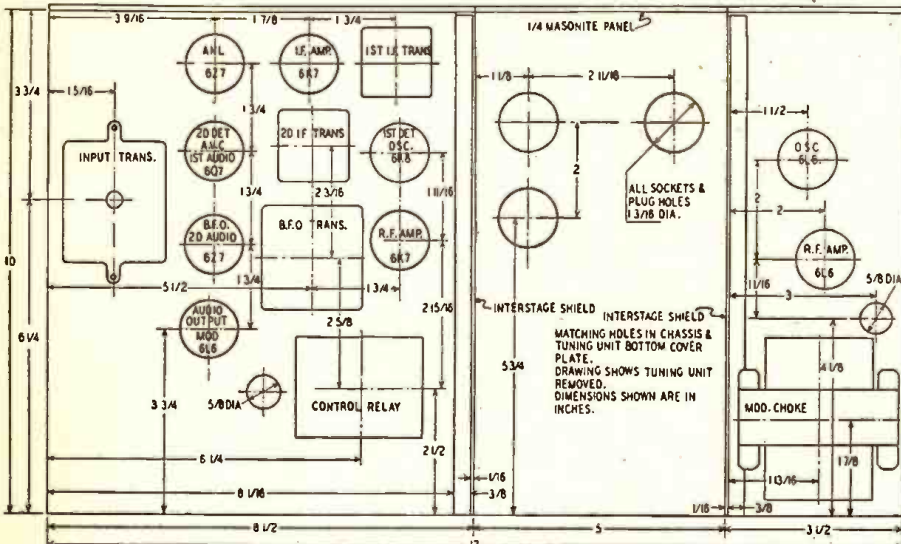

The panel layout. "Control Relay" was not used in final hookup. The 5/8-inch holes were for leads from available top-mounted components and may not be needed for different parts.

amplifier, 6Q7 second detector, a.v.c. and first audio amplifier, 6Z7 a.n.l. (automatic noise limiter), 6Z7 b.f.o. and second audio amplifier, and a 6L6 power amplifier. (See Fig. 2.)

The transmitter r.f. section uses a

a.f. voltages. The a.f. voltage is amplified by the triode section of the 6Q7 and passed on to the grid of the second a.f. amplifier (one section of a 6Z7-G) by resistance coupling. The output of the 6Z7-G drives the 6L6, which has a 30-henry choke as its plate load. Head-phones or speaker are connected to the

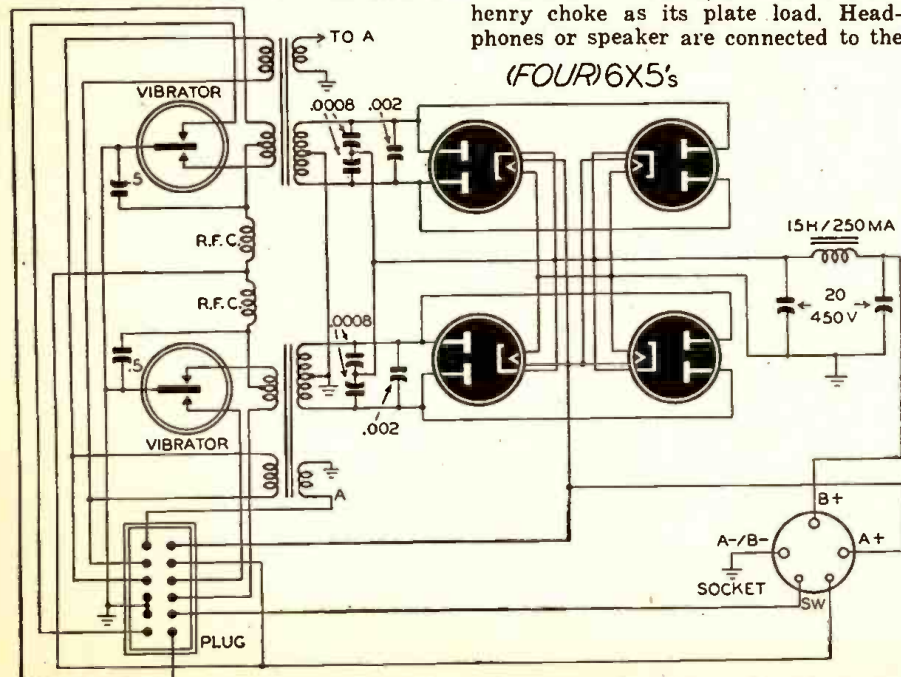
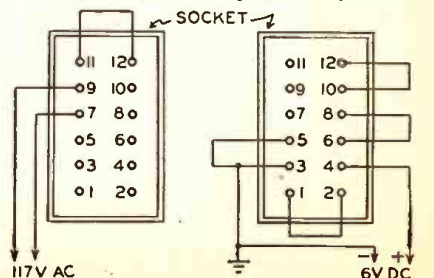

Fig. 3—Power supply. Shorting plugs (right) adapt it to 117-volt a.c. or 6-volt battery.



# VIDEO AMPLIFICATION

## Apparatus Which Works From 30 Cycles to 4 Megacycles

COMPLEX wave shapes encountered in radar, television, and some industrial electronic circuits have a very high order of harmonic content. These signals contain a wide range of frequency components—often from 30 cycles up to 4 megacycles. Amplification of such a wide band of frequencies can only be accomplished by the circuit known as a *video amplifier*.

Chief difference between a video amplifier and an ordinary audio amplifier, is that the video amplifier (Fig. 1) provides nearly constant gain over an exceptionally wide range of frequencies which include and far exceed the audio frequency band. Thus, a video amplifier might be considered an extremely high fidelity audio-frequency amplifier. A comparison of the frequency response of the two amplifier types is shown in Fig. 2.

If all of the harmonic component of a complex wave does not receive the

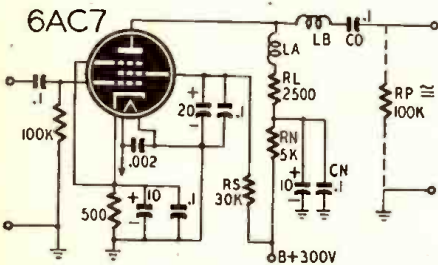

Fig. 1—A typical video amplifier circuit.

same degree of amplification, the wave shape is altered and distorted. This condition of unequal gain is known as *frequency distortion*.

If the phase delay is not constant, further distortion is introduced into the original wave shape. This is known as *phase distortion*.

1—See "Electronic Transients," *Radio-Craft*, (February, 1946).

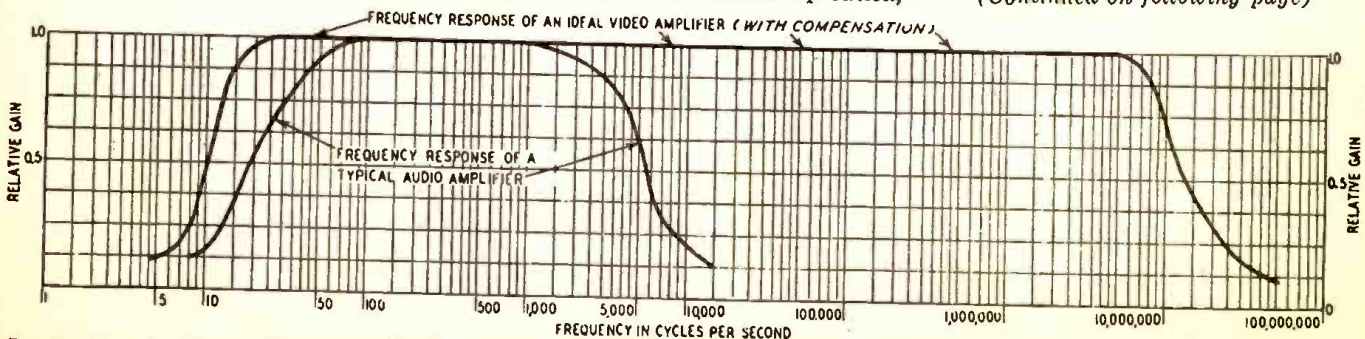

Fig. 2—A good audio amplifier may be "flat" from 30 to 8,000 cycles; a video amplifier from a few cycles to well into the megacycle range.

Ideal video amplifiers must be entirely free from both types of distortion. This is particularly true of phase distortion—the more serious—since it would result in reproduced pulses and wave shapes bearing little resemblance to the original.

However, through careful design and construction of video amplifiers it is possible to obtain and preserve a relatively flat gain response—so that all sine-wave components within the desired video range are transmitted without frequency distortion and without phase distortion.

This characteristic requirement of all video amplifiers is accomplished first, by sacrificing the amount of amplification per stage in favor of fidelity, and second, by using specially compensated resistance-coupled circuits.

### CIRCUIT ELEMENTS

Because of the wide range of frequencies involved in video amplification, it is impossible to employ either transformer coupling or impedance coupling. Use of resistance-capacitive coupling, however, presents a number of circuit problems which must be overcome.

These problems can best be understood through study of an ordinary audio amplifier.

In such a conventional circuit (Fig. 3), the high frequency response is limited by various inherent circuit capacities.  $C_T$  represents the plate-to-cathode capacity of the tube, capacities due to the physical location of wires and circuit elements, and distributed capacities of the plate circuit.  $C_P$  represents the combined input and wiring capacities of the following video stage or device. Both  $C_T$  and  $C_P$  act in parallel, and shunt the load resistance  $R_L$  of the tube in the following manner.

At low frequencies,  $C_T$  and  $C_P$  have very little effect on circuit operation,

because their reactance is large compared with the load resistance and the input resistance  $R_P$  of the following stage or device. But at very high frequencies their capacitive reactance becomes so small that these capacities behave very much like short circuits across the load resistor  $R_L$  and the input resistance  $R_P$ , respectively.

Thus it is necessary to modify con-

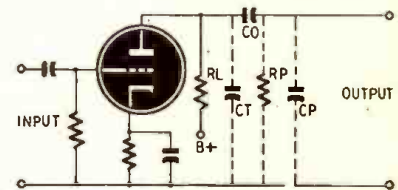

Fig. 3—Unseen components in a tube circuit.

siderably the amplifier circuit shown in Fig. 3 to adapt it for wide-band amplification.

First modification concerns a different type of vacuum tube.

The best tube for a video amplifier is one having small inter-electrode capacities combined with a large value of grid-to-plate transconductance ( $g_m$ ). Such characteristics assist directly in limiting or neutralizing some of the undesirable circuit capacities mentioned previously.

Some triodes are useful as video amplifiers. Much more preferable are pentodes and tetrodes having a high value of transconductance. Of this kind is the 6AC7/1852, the 6AG7, 6SH7, and 6SJ7. Other tubes suitable for wideband operation are the types 6AB7, 6AG5, 807, 6Y6G, 6V6, 25L6, 1231, and 1232.

The recently developed orbital-beam secondary-electron multiplier can also be used as a video amplifier. It can be used over a very wide band.

The insertion of a high  $g_m$  pentode in the original triode amplifier (Fig. 3)

(Continued on following page)

now results in the basic video amplifier circuit shown in Fig. 4. Although the inter-electrode tube capacities have been decreased by use of a pentode, the problem of distributed, reflected, and other circuit capacities must still be overcome. Further modification is necessary.

Such modification is known as *resonance compensation*, and chiefly concerns the extreme limits of high-frequency and low-frequency response of the amplifier.

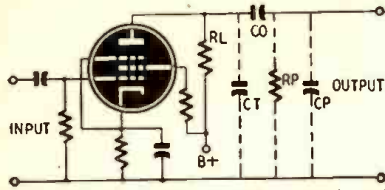

Fig. 4—Circuit of Fig. 3 with pentode tube.

frequency and low-frequency response of the amplifier.

Compensation methods which are effective at high frequencies produce little or no change in the low-frequency response, and *vice versa*. Therefore, the two problems can be considered separately.

#### HIGH-FREQUENCY COMPENSATION

Principal cause of gain decrease at the high frequencies is reduction of the plate load impedance due to the shunting effects of circuit capacities ( $C_T$ ,  $C_P$ ), (Fig. 4).

The upper frequency limit can be extended considerably—and the general high-frequency response greatly improved—if the effective impedance of the pentode and wiring capacity is *increased* at the higher frequencies of operation.

One method of increasing the reactance of a capacitive circuit is by creating a condition of parallel resonance. This, of course, will produce the greatest impedance at the resonant frequency of the parallel circuit. But if the Q of such a circuit is low, the resonance peak will be flattened out. If values of the resonant circuit are chosen so that the flat "peak" occurs in the region where normal gain of the amplifier begins to diminish, the mid-frequency or flat-gain response can be extended considerably into the high-frequency region.

For this purpose a small inductance  $L_n$  is inserted in series with the load resistor  $R_L$ , as shown in Fig. 5.

Value of the coil  $L_n$  is from 50 to 100 microhenrys. Value of the load resistance should be from 1000 to 4000 ohms.

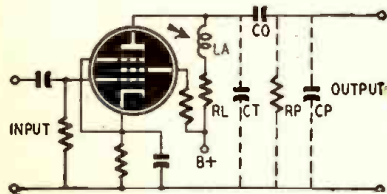

Fig. 5—High-frequency compensation circuit.

The parallel resonant frequency ( $L_n$  across the various tube and circuit capacities) is roughly the same as the upper limit of amplifier operation. This upper frequency limit rarely exceeds 3 megacycles.

This type of high-frequency compen-

sation is known as *shunt peaking*, since the coil is connected *across* the circuit.

Another method of high-frequency compensation is known as *series peaking* (Fig. 6).

In this instance, a small inductance  $L_n$  is inserted in series with the coupling condenser  $C_0$ . At the desired upper frequency limit of operation, the inductance resonates with the input capacitance  $C_T$  of the next video stage or device.

Increased current flow through  $C_T$  in turn causes an increased voltage across this capacity, resulting in higher gain and less phase shift than possible with the preceding means of compensation.

This method has a further advantage over the shunt peaking system, since the inductance  $L_n$  isolates the effects of the output and input capacities  $C_T$  and  $C_P$ .

Gain response will be substantially

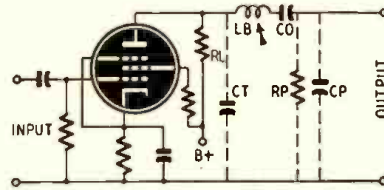

Fig. 6—Another method of h.f. compensation.

flat over the high-frequency region, comparable to mid-frequency response. And the upper limit of amplifier operation is approximately the same as the resonant frequency of the series peaking circuit.

A third method of high-frequency compensation combines the features of both shunt and series peaking. Resultant circuit (Fig. 7) gives the high-frequency extension of the shunt peaking method as well as the increased gain caused by the resonant effect of the series peaking method.

#### LOW-FREQUENCY COMPENSATION

The low-frequency response of an amplifier is influenced primarily by the

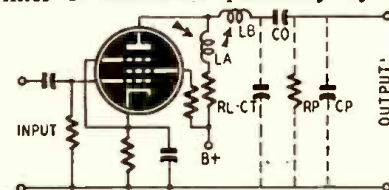

Fig. 7—Both compensation methods combined.

grid-coupling condenser  $C_0$  and the effective input resistance  $R_i$  of the following stage or device. As the frequency of operation decreases, the reactance of condenser  $C_0$  increases. And at frequencies less than about 200 cycles, this reactance causes a strong attenuation of the signal wave.

To maintain constant amplitude and a minimum of phase shift at low frequencies of operation, a compensating filter—resistor  $R_N$  and condenser  $C_N$ —is inserted in series with the load resistor  $R_L$  (Fig. 8).

As the operating frequency is decreased, the reactance of  $C_N$  increases—causing the  $R_N C_N$  combination to function as an *additional* load resistance. This action tends to increase the gain inversely (and at the same rate) as the

coupling condenser  $C_0$  tends to reduce the gain.

The compensating filter also introduces a phase displacement in the plate circuit that compensates for the phase shift caused by the coupling circuit  $C_0 R_L$ .

Low-frequency compensation may also

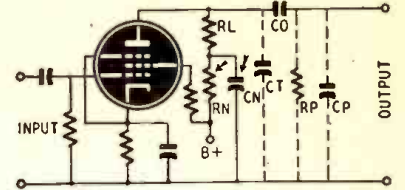

Fig. 8—Extending the low-frequency response.

be provided by a filter unit arranged in parallel with the coupling condenser  $C_0$ , as shown in Fig. 9. The resistor  $R_N$  compensates for low-frequency losses, since  $C_0$  is paralleled by the reactance of the filter condenser  $C_N$ .

Either method of low-frequency compensation may now be combined with one of the high-frequency compensation methods previously discussed, to provide a flat-gain response characteristic over a very wide range of frequencies. A typical circuit having both high- and low-frequency compensation is shown in Fig. 1, and its response curve in Fig. 2.

#### OTHER CONSIDERATIONS

There are other important circuit considerations in the design and construction of video amplifiers.

Parts and components must be arranged physically so that leads are as short as possible and properly spaced to minimize distributed capacitance between wires. Coupling condensers should be remote from other circuit elements, and *all* condensers should be mounted close to tube sockets, whenever possible.

For effective by-passing over the entire band of frequencies, electrolytic condensers shunted by small paper condensers are generally used. Cathode by-pass condensers must be extremely large to prevent any feed-back of cathode current at the very low frequencies of operation.

Necessary grid bias is usually obtained by utilizing the voltage drop across a resistor in series with the cathode. Variations caused by the input

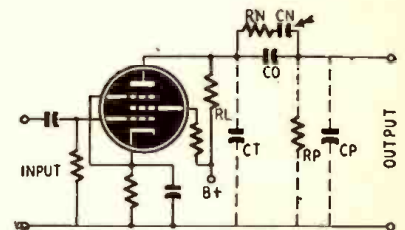

Fig. 9—Another compensation circuit for l.f.

signal are by-passed around the bias resistor by means of condensers. Time constant of the cathode resistance and capacitance should be long compared to the period of the lowest frequency to be passed. Value of the electrolytic condenser should be no less than 10 microfarads.

(Continued on page 654)

# RADIO DATA SHEET 336

## BELMONT RADIO MODEL 6D111, Series A

Tuning range ..... 530 to 1650 kc.  
I.F. .... 455 kc.  
Power consumption ..... 35 watts  
Sensitivity (for 0.05 watt  
output) ..... 10 microvolts average

Selectivity ..... 55 kc broad at 1000 x  
signal at 1000 kc  
Maximum power output ..... 1.0 watt  
Undistorted power output ..... 0.8 watt  
Voice coil impedance ..... 3.2 ohms



### ALIGNMENT PROCEDURE

- No aligning adjustments should be attempted until all other possible causes of trouble have been thoroughly checked.
- Chassis must be removed from cabinet for proper alignment. Slight adjustments of the oscillator and antenna circuits can be made, without removing the chassis, through two holes provided on the bottom of the cabinet. The two adjustment screws can be reached with a long insulated screwdriver.
- It is important that during alignment the loop antenna be

- maintained at the same distance from the chassis as when the chassis is installed in the cabinet.
- Turn volume control to maximum for all adjustments.
- Connect ground post of signal generator to B- of radio through a 0.1  $\mu$ f condenser.
- Connect dummy antenna value in series with generator output lead.
- Connect output meter across primary of output transformer.

Band	Signal Generator Frequency Setting	Dummy Antenna	Connection to Radio	Tuning Condenser Setting	Adjust for Maximum Output
I.F.	455 kc	0.1 $\mu$ f	Grid of 12SA7	Rotor full open (plates out of mesh)	4 trimmers on input and output i.f. transformers
	1650 kc	0.1 $\mu$ f	Grid of 12SA7	Rotor full open (plates out of mesh)	Oscillator trimmer C7 on bottom of radio
Broadcast	1400 kc	None	See note A	Set dial at 1400 kc	Antenna trimmer C2 on bottom of radio

Note A: Lay output lead of generator in back of loop antenna. Turn up generator output. Loop antenna will pick up energy.

### REPLACING DIAL POINTER DRIVE CORD

Six inches of cord are required in the set. Use a piece slightly longer so that knots may be tied at each end.

Rotate tuning knob to extreme clockwise position. This closes tuning condenser. Knob should remain in this position until installation is completed.

Tie knot at one end of cord and place

it in key washer. Wind cord one turn around shaft.

Pass cord over idler pulley.

Pass cord over pointer shaft; wind it one turn around shaft; pass it through key washer; wind it one more turn around shaft.

Hook spring over end of dial support. Tie cord to spring. IMPORTANT: Before

tying knot stretch spring enough so that full contraction of spring will rotate pointer shaft at least one-half turn.

Remove dial crystal by removing Cinch buttons.

Make sure tuning knob is in extreme clockwise position. Then rotate pointer clockwise, against friction of shaft, until it is in horizontal position.

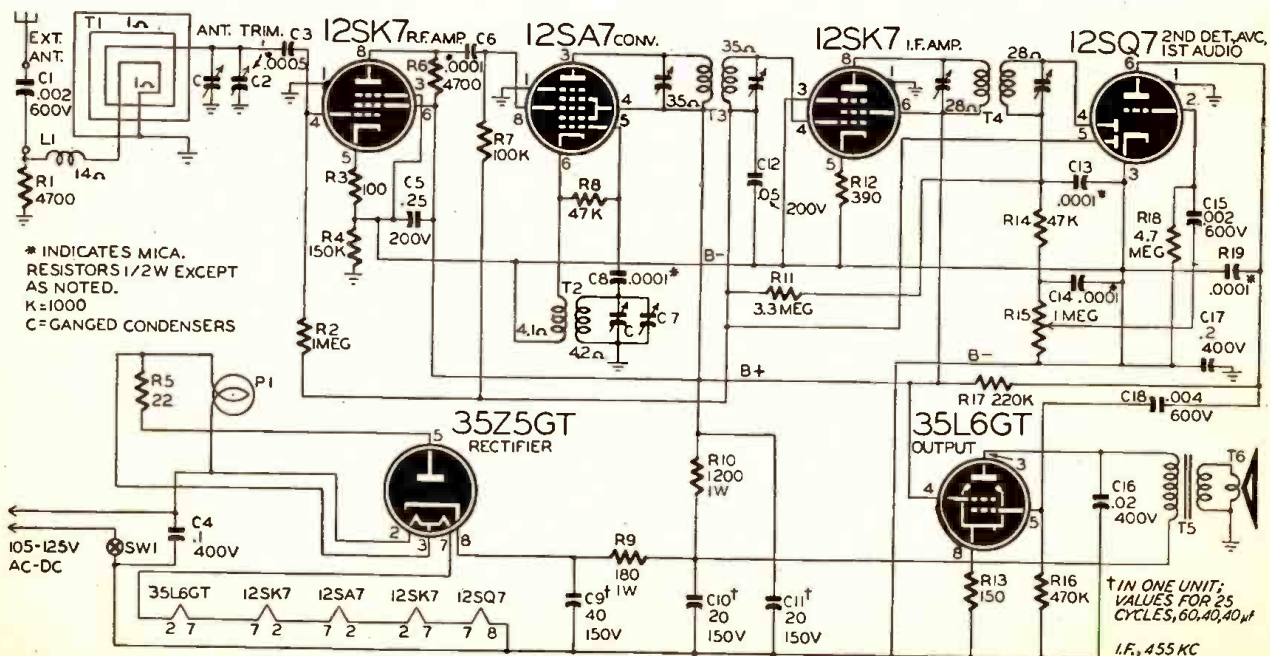

# R.F. POWER SUPPLIES

**T**HE power supply has long been a headache in the design and operation of high-voltage, low-current apparatus. The necessary iron-core transformers are bulky, heavy and expensive. They are also inefficient in these circuits because the relatively high current available from them cannot be used. Television kinescopes and electron microscopes require, in general, less than one milliamper. High-voltage insulation between windings makes the transformer very expensive.

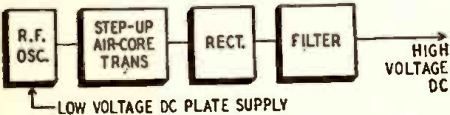

Fig. 1—Components of high-voltage r.f. pack.

A radio-frequency circuit eliminates the main disadvantage—the iron-core transformer supply. An r.f. oscillator is operated at a high radio frequency. The output is stepped up (in an air-core transformer), rectified and filtered to give the high d.c. voltage at low values of current. The results:

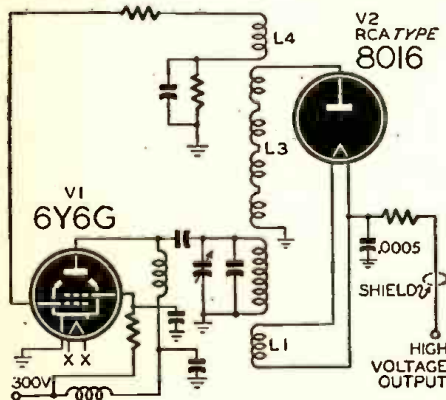

Fig. 2—The unit uses a receiving-type tube.

1. *Compactness.* The large iron-core transformer and filtering components are eliminated.

2. *Light weight.* The heavy iron core which made up most of the weight of the power supply is no longer required. Small filter condensers are sufficient.

3. *Safety.* The output current from the circuit is definitely limited even under short-circuit condition. A filter condenser of about 500  $\mu\text{mf}$  can hold only a relatively small quantity of electricity. This reduces the danger of shock or injury.

4. *Economy.* Elimination of the large and expensive iron-core transformer and reduction in size of filter components permit a substantial reduction in cost.

A block diagram of the power supply is given in Fig. 1. The oscillator can be a receiving-type tube since the output power required is small. Because of the high frequency and small current, filtering is simple.

A recently announced commercial type of television power supply\* is illustrated in the photograph and schematic (Fig. 2). Note the compactness and simplicity of design. A beam power 6Y6G is used as oscillator, an RCA 8016 as rectifier. The latter tube filament requires only  $\frac{1}{4}$  watt, easily supplied from a fractional turn of wire on the high-voltage transformer. The unit is definitely portable and can be placed anywhere without danger of supply-line-frequency pickup by other circuits.

Figs. 3 and 4 give performance data of this supply. The voltage regulation is 15% from no load to 800 microamperes drain. The frequency characteristic is not critical, optimum being ob-

\* U. S. Television, New York City.

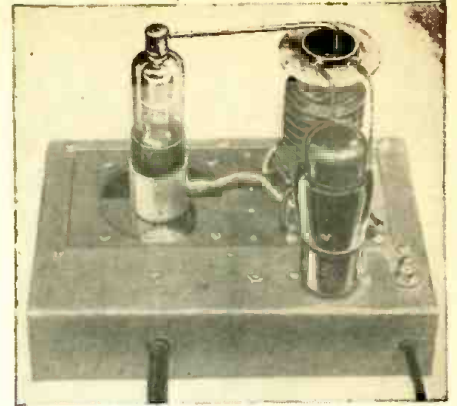

Appearance of the commercial r.f. power unit.

tained at about 300 kc. This model is adapted to operate up to 14-inch direct-viewing kinescopes and similar tubes, and is available either with or without the d.c. oscillator power supply. The earlier types have an adjustable output of from 6000 to 10,000 volts.

A higher voltage model for the projection type kinescopes is also available. Due to a voltage-tripling circuit, the output is 30,000 volts.

Design considerations in this type of supply are

- (a) eddy current loss
- (b) voltage insulation
- (c) resonance curve
- (d) voltage regulation

Note the use of a pie-wound transformer secondary to guard against voltage breakdown. The coefficient of coupling between primary and secondary determines the double-humped shape of resonance curve and voltage regulation.

The advantages of a well-designed r.f. oscillator-rectifier combination make it an ideal source of supply for oscilloscopes or other cathode-ray tube applications, as voltage is usually high and current low. The suitcase-type electron microscope owes much of its portability to the use of such a power supply.

Although r.f. power supplies have not come into common use, they are by no means entirely novel. Design and operation of such a unit was described by O.H. Schade, of the Radio Corporation of America, in a paper published in *Radio-Craft*, June, 1946.

(Continued on page 647)

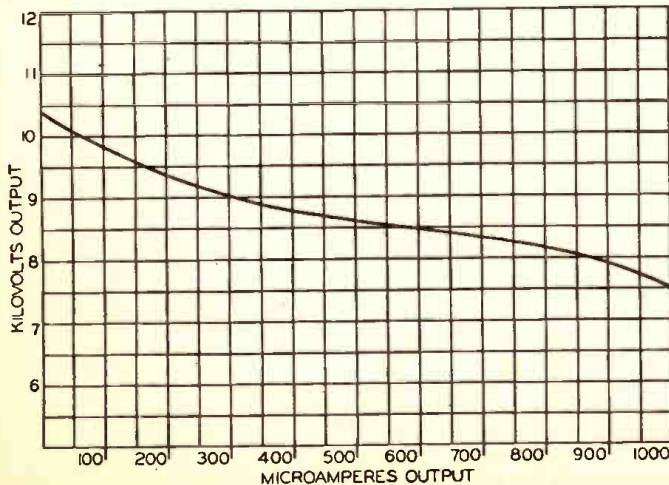

Fig. 3—Regulation curve, output voltage plotted against current.

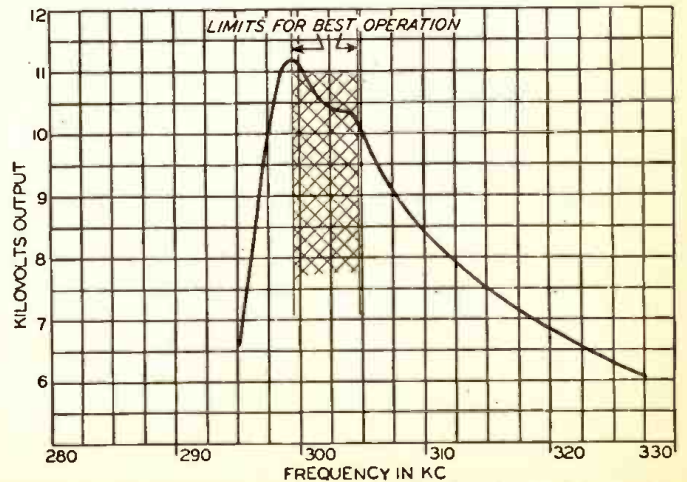

Fig. 4—Practical operating frequencies for this type of apparatus.

# MATHEMATICS - RADIO TOOL

## Part I—Some Problems of Receiver Design and Operation

**W**HENEVER the word "mathematics" is uttered in radio circles, not too infrequently the novice and radio veteran are alike gripped by fear. They imagine the subject to be dull, abstract, and very difficult; something to be avoided at all costs! The appalling situation can be attributed, in no small measure, to the poor pedagogical methods in our schools.

All sciences owe a great deal to mathematics for their development. This is particularly true of radio and electronics. We deal with substances and terms which are completely insensible to the human organs and alien to our imagination. We try to understand them by meager analogies; electricity depicted, for example, as flowing water. To fully comprehend the principles and enable us to solve many practical problems in radio work, mathematics is a vital necessity. In the following, we present a number of radio problems and their solutions. They are designed to illustrate how important a tool mathematics can be to the radioman. Only simple arithmetic will be assumed on the reader's part, ordinary common sense being the most important factor in understanding the following.

### THE CATHODE BIAS RESISTOR

A very frequent problem is the determination of the cathode resistance value of a vacuum tube. For example, what value resistor is required for a 6C5 triode operating as a class A amplifier, with a plate voltage of 250 volts? (Fig. 1).

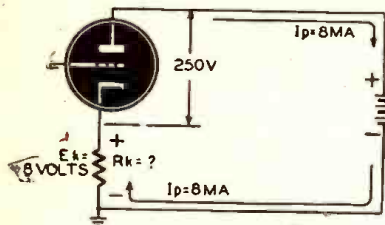

Fig. 1—Calculation of tube's cathode bias.

Turning to the tube manual, we find the grid-bias voltage to be -8 volts and the plate current, 8 milliamperes. Using Ohm's Law and some arithmetic, we solve the problem.

The formula—

$$R_k = \frac{E_k}{I_p} \times 1,000$$

Where  $R_k$  = resistance value of grid-bias resistor in ohms,  $E_k$  = grid-bias voltage in volts, and  $I_p$  = plate current in milliamperes.

Substituting the known values in the formula, we have—

$$R_k = \frac{E_k}{I_p} \times 1,000 = \frac{8}{8} \times 1,000 = 1,000 \text{ ohms}$$

Where tetrodes or pentodes are employed, we follow the same method as above in obtaining the solution, with the added necessity of taking the screen current into account. This is shown in the new formula—

$$R_k = \frac{E_k}{I_p + I_s} \times 1,000$$

where  $I_s$ , the new factor, is the screen current in milliamperes.

What should the wattage rating of the resistor be? Again, mathematics will supply us with the answer.

Using the formula:  $W = E_k I_p$

Where  $W$  = rating of resistor in watts,  $E_k$  = grid-bias voltage in volts, and  $I_p$  = plate current in amperes.

Substituting the known numbers in the formula—

$$W = E_k I_p = 8 \times 0.008 = 0.064 \text{ watts}$$

Since there is no resistor available rated at 0.064 watts, we would use a 1/4-watt resistor. Commonly, the wattage rating of a resistor is at least twice the calculated value, so a 1/2-watt resistor would be the smallest practical one, which would include the 100 percent safety factor.

### LINE-CORD RESISTORS

The replacement of a line-cord resistor is a task the radio-serviceman is often called upon to perform. In this case, to solve the problem, his tool is not the conventional ohmmeter, but arithmetic.

Let us assume a five-tube a.c.-d.c. superhet, using a 6SA7, 6SK7, 6SQ7, 25A6, and a 25Z6, is brought in for repair. A continuity test points to an open line-cord resistor. With what value line-cord resistor should it be replaced? (Fig. 2).

From the tube manual, the serviceman finds that each tube draws 0.3 ampere. Then, he notes down the heater voltage of each tube, and adds them up. There are three 6.3-volt and two 25-volt tubes; total, 68.9 volts.

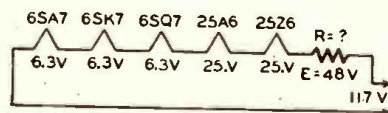

Fig. 2—The old line-cord resistor problem.

In an a.c.-d.c. circuit, the tube filaments are connected in series. Therefore,

the same current, 0.3 ampere, will flow through each tube.

Since the line voltage is approximately 117 volts, our problem is to drop (117-68.9), or about 48 volts. Using Ohm's Law—

$$R = \frac{E}{I}$$

Where  $R$  = the required resistance in ohms,  $E$  = the voltage to be dropped in volts, and  $I$  = the current flowing through the tubes, in amperes.

Substituting the known values in the formula, we have—

$$R = \frac{E}{I} = \frac{48}{0.3} = 160 \text{ ohms}$$

Therefore, the line-cord resistor should be 160 ohms. The wattage is found by using the formula  $W = EI$ , and doubling the calculated value.

### VOLTAGE DIVIDER PROBLEMS

In power supplies, a voltage divider is often utilized. It is a tapped resistor connected across the output of the power source, supplying different voltages to the stages of a circuit.

To cite an example, the following voltages and currents are needed.

$E_1 = 250$  volts, 20 ma,  $E_2 = 100$  volts, 15 ma, and  $E_3 = 50$  volts, 10 ma.

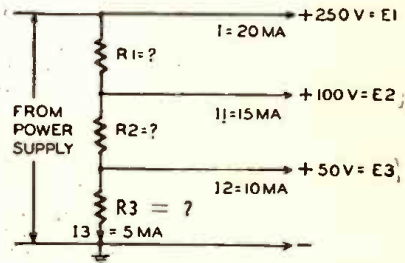

Fig. 3—How to calculate the voltage divider.

The problem is to solve the resistance values between the taps. (Fig. 3). Before we unravel the problem, a current of about 10 percent of total load current, known as the bleeder current, must be allowed for. (In this case, the total load current is equal to 20 ma + 15 ma + 10 ma or 45 ma). The bleeder current will then be about 5 ma. Referring to Fig. 3, we proceed as follows:

Let— $I_1 = 15$  ma (the current flowing through the load connected across the 100-volt tap),  $I_2 = 10$  ma (the current flowing through the load connected across the 50-volt tap), and  $I_3 = 5$  ma (the bleeder current).

(Continued on page 635)





# REDUCING HUM LEVELS

## Hum Level of Many Receivers Can Be Notably Reduced

**R**ECEIVER performance can be improved greatly by reducing hum level. Work of this kind can be profitable if "sold" to the customer, but not everyone will want hum level reduced. Many are not particularly fussy about reception and will be satisfied so long as some sound comes out of the "box." Others may appreciate quality and be willing to pay for it.

Lack of hum in a battery set is very noticeable. With the volume control set at zero, and no signal input, no hum can be heard. In an a.c. or a.c.-d.c. set, a definite hum can be heard at zero volume control setting or when the radio program is interrupted, as at station-break time. This hum level—sometimes called "residual" hum—is a part of the radio design. It is usually not reduced to absolute zero but is made low enough that ordinarily it is not noticeable.

The hum heard in the service shop may be less noticeable than in the home or place where the radio is used. The reason primarily is that noise level in the shop may be high, preventing the serviceman from hearing the hum very efficiently. Baffling effect of a cabinet is also absent on the bench, often causing strong 60-cycle hum to be inaudible. By turning off other sets and keeping shop noise down to a low level when checking hum, better accuracy in making the listening test is possible.

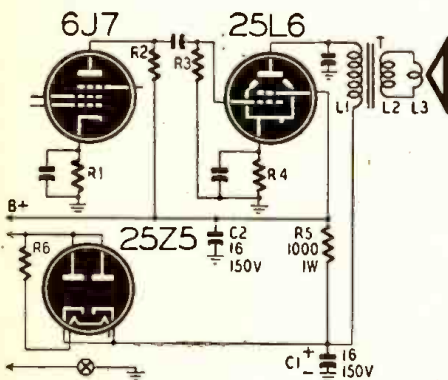

Fig. 1—Hum voltage sources in a.c.-d.c. sets.

Many of the less expensive sets have little filtering, since filter parts cost money and that increases the cost of manufacturing the radio. It might be impractical to use extensive hum reduction on many thousands of radios in manufacturing, but in specialized servicing, for superior results, it is a practical matter to see about reducing the hum to a very low level.

One common type of circuit is that shown in Fig. 1. In this circuit, a hum

voltage exists across  $C_1$ , the input filter condenser. This hum voltage is applied to the series circuit consisting of  $L_1$ , the plate-to-cathode resistance of the output tube and to  $R_1$ . The value of  $R_1$  may be about 150 ohms and, since it is shunted by a high capacity condenser, the impedance in the cathode circuit may be assumed to be very low at the fundamental and low-order harmonic hum frequencies. Small dimensions of the midget cabinet and poor loudspeaker response at 60 cycles may mean that the hum at second harmonic 120 cycles, will be most noticeable, and hum at 180 and 240 may be appreciable. Rectified alternating current from the cathode of the 25Z5 consists of two components, the d.c. and an imposed a.c., or hum voltage. Such voltage appearing in the plate circuit of the 25L6 would be heard in the speaker. We may think of this 60-cycle hum component as having two paths—one to ground through  $C_1$ , and the other through  $L_1$ , the internal resistance of the tube and the cathode resistor and its by-pass condenser. Even at 60 cycles, the reactance of the condenser is only 166 ohms, whereas that of the parallel circuit amounts to some thousands of ohms. As the hum frequency is made higher, the reactance of  $C_1$  decreases and that of  $L_1$  increases, further reducing the tendency for hum to flow in the plate circuit.

In the screen grid circuit, filtering is obtained through  $R_2$  and condensers  $C_1$  and  $C_2$  which offer low impedance paths for hum currents.

A reduction in hum can be obtained by using a small iron core inductance in series with  $R_1$ . If the choke d.c. resistance is 200 ohms,  $R_1$  may be reduced to 800 ohms. Usually,  $R_1$  can be dispensed with entirely when the choke is substituted without noticing any bad effects. If the choke is a 10-henry type, its reactance at 60 cycles is 3768 ohms. The d.c. voltage drop in the choke will be low, but the impedance to hum will be much higher than that offered by the 1000-ohm resistor, reducing the hum level. At 120 cycles, the impedance would be even higher, about 7536 ohms. If a 30-henry choke is used, at 60 cycles, the impedance would be 11,304 ohms, while at 120 cycles it would be 22,608 ohms. (Using the choke in series with the entire B supply may be undesirable since the high plate current of the output tube results in near-saturation of the choke and decreased inductance.)

An ordinary carbon resistor, such as  $R_1$ , will have no appreciable reactance and may be considered a pure resistance, so that its opposition to hum harmonics

is the same as that to the fundamental hum frequency.

Hum can also be reduced, of course, by increasing the values of  $C_1$  and  $C_2$ . Usually  $C_2$  is not very critical and a 30- $\mu$ f 150-volt unit can be used, but  $C_1$  must not be made too large in value. Using a very large condenser here will raise the peak current through the recti-

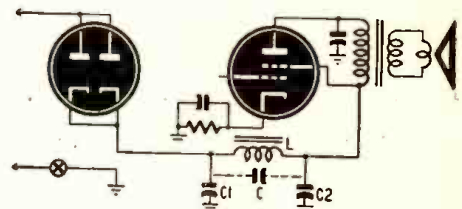

Fig. 2—Tuned-choke circuit, a rarer type.

fier tube and possibly shorten its life. It may also give too much output voltage. Using a choke, the original operating voltages are not disturbed very much. In many cases, however, installing a 20- or even 30- $\mu$ f unit in place of  $C_1$  will work out all right. A 40- $\mu$ f or higher condenser should not be used in place of  $C_1$ . If the original circuit had a very high capacity input, the use of a similar condenser in servicing, naturally, would be all right.

In Fig. 2, a less widely-used type of circuit is shown. Hum output from the rectifier is a 60-cycle hum, since a half-wave rectifier is used. It may be possible to tune  $L$ .  $L$  may be a speaker field or a choke. If the inductance is 30 henrys, the reactance at 60 cycles will be about 11,304 ohms. When the reactance is known, the condenser capacitance can be found using a formula,  $X_c = 1/6.28 \times C$  (farads), a condenser in the neighborhood of 0.25 will be found to have the same reactance.

Using an a.c. voltmeter, and connecting it across the output filter  $C_2$ , the reduction in hum output can be noted as various values of  $C$  are shunted across  $L$ . Tuned-filter reduction is primarily at the fundamental hum frequency. Above resonance, for example at 120 cycles, the second harmonic hum output of the half-wave rectifier, the 0.25  $\mu$ f condenser would have a reactance of 5300 ohms. The reactance of the .25  $\mu$ f condenser, would be in shunt with the choke impedance and the net impedance would be something less than 5300 ohms. For higher harmonic frequencies, the impedance would progressively become less, since the reactance of the condenser drops off with a rise in frequency.

(Continued on page 648)

# "RADIO PEN" 28 YEARS OLD

Dr Lee de Forest Original Inventor

**A**FTER having published Fips's lurid account of his Radio Pen, which caused him to be immediately fired, cashiered, dismissed, and forbidden to ever re-enter the premises, for his dastardly conduct in stealing inventions of others (see article RADIO PEN, April issue), RADIO-CRAFT received a letter from Dr. Lee De Forest, who writes in part as follows:

"Mr. Hugo Gernsback  
"Editor, RADIO-CRAFT

"I notice that your April issue illustrates and partly describes the 'Radio Pen.' I remember distinctly that I made complete drawings and specifications of such a pen away back, either in the early 20's or possibly as far back as 1917. My recollection is that one of your magazines made quite a feature of this. At that time, the smallest available radio tube was the 'peanut,' made by Western Electric.

"If you are sufficiently interested, I suggest that you have one of your men dig back through those early files to see if that published description can be located. If so, will you not please reproduce it? You see, I am just as jealous as you are to be known as an early prophet!"

Sincerely yours,  
LEE DE FOREST

Dr. De Forest's memory is very good. We located the article in the June 1918 ELECTRICAL EXPERIMENTER, an early Gernsback publication.

We reprint here a condensation of the article, and also the illustrations that went with it. It certainly makes interesting reading.

In defense of Fips; we are certain that he did not remember Dr. De Forest's original account, because no reference to it was made anywhere in his papers, through which we looked carefully after his brusque dismissal.

We did, however, find the following: He had made numerous notes on other miniature radio receivers, to wit:

- POCKET LIGHTER RADIO
- TIE-STICK PIN RADIO
- EARRING RADIO (For ladies)
- COLLAR-BUTTON RADIO
- CUFF-LINK RADIO

This should give a good idea how his mind works.

Of course, it will probably turn out that neither of the suggestions mentioned are original with him. We are certain that somewhere, some patentee or an early inventor will sooner or later claim credit.

All this is as it should be. Most so-called "inventors" these days find that after they are through with their laborious work they discover that their brain-child is as old as the hills, and that somebody had preceded them possibly before they were even born.

Dr. De Forest's article from the June 1918 issue ELECTRICAL EXPERIMENTER follows:

## A "FOUNTAIN PEN" RADIO RECEIVING SET

To Dr. Lee De Forest must be given the credit for developing a receiver which is only slightly larger than an ordinary fountain pen. With it, a secret service man has but to walk in the vicinity where a "spy radio station" is suspected, with the chance that he may locate the informer at his instrument.

With this "fountain pen" radio receiver it has been possible to hear stations eight to ten miles away, with little difficulty and only a small aerial. In the sectional view shown here it may be seen how it is hooked up. This sensitive receiver depends entirely upon the Audion for its efficiency, and it is only this extremely sensitive detector that has made possible a truly practical receiver of this small type.

It has been found that by using what is known as a "soft" Audion a fair degree of sensitiveness is achieved with a battery of only four volts, whereas a standard Audion requires a potential many times that amount.

The tuning of the set is accomplished by means of a small coil, wound with No. 40 magnet wire. Taps are taken off from the coil and led to a number of points over which slides a contact mounted on the movable cap at the end of the receiver. By moving the cap one way or another the wave-length is altered to conform with the in-coming wave. The tuning coil answers satisfactorily for short wave-lengths, and



The older (and much bigger) Radio Pen had a range of 10 miles.

the Audion is connected directly to it, having an untuned secondary. The battery is placed in the middle of the receiver and at the end is placed the telephone receiver consisting of a special magnet, bobbin, diaphragm and earpiece. The antenna and ground connections are instantly made by a special double contact plug.

To operate the instrument the person using it has a metal plate attached to the heel of one shoe, to which is attached the ground wire leading to the set, the wire being passed through the trouser leg so as not to be seen. The wire to the antenna is run down through the coat sleeve and into a hollow cane which may contain a spiral aerial or a similar arrangement.

Standing against an iron fixture which connects with the ground the operator places the metal electrode on the heel in contact with the same. The cane containing the antenna is held over the shoulder or in any position not likely to cause attraction. The earpiece is placed against the ear and the other end adjusted till the signals are heard loudest.

## CORRECTION

The coil table mentioned in the article "A Portable Shop," published in the February issue, was inadvertently omitted. As a large number of readers have written to ask about the table, it is reproduced below.

No doubt many readers have already constructed the apparatus, using coils of their own design. If they have arrived at values which cover the spectrum and oscillate satisfactorily, it will not be worth while to modify them to conform with the table. Any set of coils that cover the bands is correct. In many cases the cathode tap will have to be varied from the point given, to accommodate individual differences.

### Coil Table

(all coils are wound on 1½ in. forms)  
I.F. coil (456 kilocycle) No. 26 enamel wire, 170 turns close wound; cathode tap 50 turns from ground.  
Broadcast—No. 22 d.c.c. 100 turns close wound; cathode tap 13 turns from ground.  
80 Meter—No. 22 d.c.c. 29 turns close wound; tap 2 turns from ground.  
40 Meter—No. 22 d.c.c. 16 turns spaced 1¼ inch; tap 1½ turn from ground.  
20 Meter—No. 22 d.c.c. 7 turns spaced 1¼ inch; tap 1½ turn from ground.

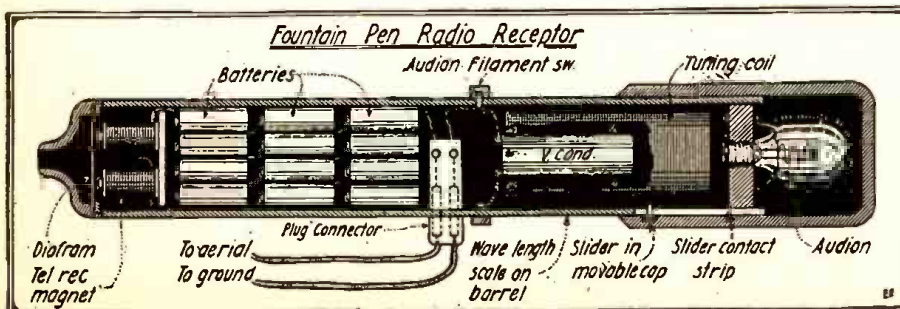

Unlike Mohammed U. Fips' later invention, this early pen required an aerial and ground.

# THE WORLD'S MOST FAMOUS BOOK FOR RADIO-ELECTRONIC BEGINNERS (No previous training necessary)



**A. A. GHIRARDI**  
Let Radio's most widely-read technical author help you start training NOW for a fascinating, profitable future!

**LEARN RADIO-ELECTRONICS EASIER BETTER FASTER for Only \$5.**



**YOUR MONEY BACK**  
in 5 Days if Ghirardi's 972-page RADIO PHYSICS COURSE Book doesn't teach you Radio-Electronic fundamentals EASIER, FASTER and at LESS COST than any other book! That's how sure we are that Ghirardi's RADIO PHYSICS COURSE is the very best in the field!

## HERE'S HOW TO REPAIR RADIOS THE EASY WAY!

### A Definite Guide for Diagnosing, Locating and Repairing Radio Receiver Troubles

Radio servicemen everywhere say that this big, 3rd edition of A. A. Ghirardi's RADIO TROUBLESHOOTER'S HANDBOOK helps them turn out twice as much work in a given time! Radio "tinkerers" and beginners who like to fix their own home sets and those of friends find this big book a quick, easy way of locating and repairing receiver troubles without extensive shop equipment! Nine times out of ten, it tells exactly how to make the necessary repairs—without any elaborate testing whatever!

#### NOT A "STUDY" BOOK

Actually, this big, 744-page manual-size RADIO TROUBLESHOOTER'S HANDBOOK is a complete guide to the trouble diagnosing, locating and fast repairing of PRACTICALLY EVERY TYPE OF RADIO RECEIVER NOW IN USE. It isn't a "study" book. You simply turn to it whenever you want to fix a particular type of trouble in a particular make of radio. Its 104-page Case History Section

gives full details on common trouble symptoms, their causes and remedies for OVER 4,000 DIFFERENT RADIO RECEIVER MODELS. It describes the trouble exactly—tells exactly how to repair it. It eliminates extensive testing—helps you do two jobs in the time normally required for one—repair cheap sets at a profit—substitute tubes and parts profitably—train new helpers, etc., etc.

In addition, hundreds of other pages are devoted to the most modern tube chart you've ever seen; tube and parts substitution data; I-F alignment peaks for over 20,000 superhets; a big section on I-F transformer troubles—and dozens of charts, graphs, helpful hints and data compilations—all carefully indexed for quick, easy reference.

This big, beautifully bound HANDBOOK is only \$5 (\$5.50 foreign) on our UNRESERVED 5-DAY MONEY-BACK GUARANTEE. You cannot lose!

### MOST POPULAR FOR ARMY-NAVY AND CIVILIAN RADIO TRAINING

This same inexpensive book has given more people their basic Radio-Electronic training than any other ever published. It is more widely endorsed by men who know. Because of its sheer merit, it is more universally used for home study, and more widely employed in U. S. Army Signal Corps, Navy, and civilian schools and colleges than any other book on the subject. Would you want any better proof than this?

### EVEN IF YOU DON'T KNOW ANYTHING ABOUT RADIO!

Even if you've had no previous Radio or Electrical training or experience, it's easy to learn from Ghirardi's RADIO PHYSICS COURSE! Everything that can be done to make learning easy has been done for you. It painstakingly explains everything in detail so you cannot fail to understand. Over 500 specially prepared illustrations help you to visualize every action, Radio in advance. All you need is a little reading time and a desire to get started RIGHT for a profitable future in any of Radio-Electronics' many branches—from service work to aviation, military, broadcasting, manufacturing, public address and many others.

### SCOPE OF 36 COURSES IN ONE

Actually, RADIO PHYSICS COURSE gives you the scope of 36 different courses in one convenient, inexpensive big book. Nothing is left out. Nothing is condensed. Nothing is left to chance. You learn all you need to know. You don't need to wait for monthly lessons. You progress as rapidly as you wish in your spare time and in the comfort of your own home.

### A \$50 VALUE FOR \$5 COMPLETE

RADIO PHYSICS COURSE is acclaimed everywhere as the "biggest bargain" available in Radio-Electronic training. If it were broken into sections and sold as a course, you'd regard it as a bargain at \$50 or more—but you actually buy it all here complete in one big 972-page handsomely bound book for only \$5 (\$5.50 foreign) and with our absolute 5-DAY MONEY-BACK GUARANTEE. Get the book and see for yourself. Compare it with any other book or course on the market—at any price. See how much more complete it is, how much better illustrated, how much easier to understand! You be the judge! You cannot lose!

**WARNING!** Paper shortages may make it impossible for us to continue meeting the tremendous demand for all Ghirardi Radio Books. Don't take chances! Order yours today while they're still available. Use this Order Form.

## HOW TO LEARN PROFESSIONAL RADIO SERVICE WORK

... without an instructor!

A. A. Ghirardi's MODERN RADIO SERVICING is the only single, inexpensive book that gives a complete, easily understandable course in modern radio repair work in all of its branches. Written so simply you can understand it without an instructor! Read from the beginning. It takes you step by step through all phases of the work—or, used as a reference book by busy servicemen, it serves as a beautifully cross-indexed work for "brushing up" on any type of work that may puzzle you.

Included is a thorough explanation of all Test Instruments, telling exactly how they should be used and why (it even gives all necessary data for the construction of test equipment for those who prefer to make their own); Receiver Testing and Repair Procedure and Circuit Analysis; Testing and Repair of Components; Installations; Adjustments; etc., etc.—also How to Start a Successful Service Business. 1300 pages; 720 Self-Testing Review Questions; 706 helpful illustrations and diagrams. Only \$5 complete (\$5.50 foreign) on our 5-Day Money-Back Guarantee.



### SAVE MONEY!

See coupon for special combination offer on MODERN RADIO SERVICING and TROUBLESHOOTER'S HANDBOOK—over 2040 pages of helpful service data!

# REPAIR ANY KIND OF RADIO EQUIPMENT PREPARE YOURSELF FOR A BETTER JOB AT HIGHER PAY IN THE RADIO-ELECTRONIC FIELD

RADIO-CRAFT for JUNE, 1946

TECHNICAL DIVISION, MURRAY HILL BOOKS, INC.  
Dept. RC-66, 232 Madison Ave., New York 16, N. Y.

Enclosed find \$..... for books checked; or  send C.O.D. for this amount plus postage. If I am not fully satisfied, I may return the books within 5 days and receive my money back.

RADIO PHYSICS COURSE \$5.00 (\$5.50 foreign)  3rd. Edit. RADIO TROUBLESHOOTER'S HANDBOOK \$5.00 (\$5.50 foreign)

**MONEY-SAVING OFFER** — Get both Modern Radio Servicing AND Radio Troubleshooter's Handbook at only \$9.50 (\$10.50 foreign)  MODERN RADIO SERVICING \$5.00 (\$5.50 foreign)

Name .....

Address .....

City ..... City Dist. No. .... State .....

# WORLD-WIDE STATION LIST

**A**T last the effect of sun spots and the northern lights have diminished and some fair reception has been enjoyed by our observers. We sure hope that it will last a while so that some of the dx can be written into the log. The best European reception seems to be coming from the Swiss transmitters at Berne. 6.345 megacycles is very good at 8:30 pm on and 7.380 is fair at the same time. Some code interference is heard on the latter, however.

A new Mexican has been reported on 11.80 megacycles at 1 to 11 pm. The call is XERH. Brazzaville is now heard on 9.980 megacycles at 5 to 8 pm; with the news at 5:15 and 6:30 pm. On 9.745 megacycles, Leopoldville is again being heard at 1 to 9:30 pm daily. These

same programs can also be heard on 9.350 megacycles, at the same hours. This is a new frequency for this transmitter.

VUD3 from Delhi, India, is now being heard on the east coast occasionally at 8:30 to 11:30 am. Reception is fair from this one. VE9AI has discontinued use of the 6.005 megacycle frequency. The German transmitter at Leipzig is being heard from 3 to 7:45 pm and from midnight on. It is a very good signal, and easily received. Identification is by the piano notes of the old folk song used by Berlin transmitters before and during the war. It is the best German heard in a long time. Programs are in the Home Service and is in all German language.

KU5Q on Guam is still good around 7

am on 9.670 megacycles. ZQI in Jamaica is heard from 4:30 to 6:30 pm on 4.700 megacycles.

Reception reports on HIT should be sent to Calle Arzobispo Nouel 24 altos, Ciudad Trujillo, Dominican Republic. Reports should be in Spanish, and be sure to inclose international reply coupon. The programs are heard nightly on 6.630 megacycles until sign-off at 9 pm. The station identification is made by a man who says, "El HIT Del Airo," and sign-off is followed by the National Anthem.

XEBT in Mexico City is also sending verification cards in return for good, complete reports, which should be in Spanish. They are heard very well about 8 pm on 9.625 megacycles.

All schedules Eastern Standard Time.

Freq.	Station	Location and Schedule	Freq.	Station	Location and Schedule	Freq.	Station	Location and Schedule
11.800	JZJ	TOKYO, JAPAN: 9 to 10 am.	12.070	CSW	LISBON, PORTUGAL: heard 1:30 to 3 pm	15.210	KGEX	SAN FRANCISCO, CALIF.: Phil- lippe beam, 4 pm to 1:45 am.
11.810	WLWL	CINCINNATI, OHIO: European beam, 6 to 7:45 am; 1 to 5:45 pm.	12.080	PST	RIO DE JANEIRO, BRAZIL: 6 to 7 pm	15.210	WBOS	BOSTON, MASS.: European beam, 6 am to 12:45 pm.
11.810	ZOJ	COLOMBO, CEYLON: 5 am to noon.	12.080	GRF	MOSCOW, U.S.S.R.: 8 to 11 am.	15.220	CHTA	MONTREAL, CANADA.
11.820	GSN	LONDON, ENGLAND: New Zealand beam, 12 to 1 am; African beam, 1 to 4 pm.	12.095	GRF	LONDON, ENGLAND: Near East beam, 1 to 3:15 am; 11 am to 12:45 pm; Italian beam, 1 am to 12:45 pm.	15.230	JTL3	TOKYO, JAPAN: 5:15 to 7:15 pm.
11.826	WCRC	NEW YORK CITY: European beam, 5 to 10:30 am.	12.110	H13X	CIUDAD TRUJILLO, DOMINICAN REPUBLIC: noon to 2:30 pm; 6 to 10:30 pm.	15.230	VL66	MELBOURNE, AUSTRALIA: North- ern Australia beam, 10 to 10:25 pm.
11.830	WCRC	NEW YORK CITY: European beam, 10:45 am to 4:30 pm; South Amer- ican beam, 5 to 11 pm.	12.175		MOSCOW, U.S.S.R.: 6:45 to 7:45 am; 8:30 to 10:30 am; noon to 1 pm; 7 pm to 1 am.	15.230	WLWL2	CINCINNATI, OHIO: North African beam, 6 to 7:45 am; 8 am to 12:45 pm; 1 to 5:45 pm.
11.830		MOSCOW, U.S.S.R.: 10 pm to 2 am; 6 to 8 am; 11 to 11:30 am; 6 to 7 pm.	12.190	LSN3	BUENOS AIRES, ARGENTINA: 6.15 pm.	15.240	KNBX	MOSCOW, U.S.S.R.: 5:45 to 6:25 pm; 6:45 to 8:15 am; 3 to 3:45 pm.
11.835	CXA19	MONTEVIDEO, URUGUAY: 6 am to 10 pm.	12.210		VIENNA, AUSTRIA: afternoons at 4:30 pm.	15.250	WLWK	SAN FRANCISCO, CALIF.: Oriental beam, 3:45 to 8:45 pm.
11.840	GWQ	LONDON, ENGLAND.	12.250	WXFD	ALASKA: 8 pm to midnight.	15.250	WLWR	CINCINNATI, OHIO: South Amer- ican beam, 5 to 7:15 pm.
11.840	VLG4	MELBOURNE, AUSTRALIA: North American beam, 12:10 to 12:45 am; 10 to 10:45 am; New Caledonia beam, 3:10 to 4 am; Southwest Pa- cific beam, 4:30 to 5:15 am; Asiatic beam, 5:15 to 6:45 am.	12.255	KU5Q	GUAM: 5 am; 7 pm to midnight.	15.260	GS1	LONDON, ENGLAND: African beam, 10:30 am to 2:15 pm.
11.840	VLC7	SHEPPARTON, AUSTRALIA: Tshiti beam, 1 to 1:40 am.	12.265		MOSCOW, U.S.S.R.: 4 to 5:30 pm; 8 to 9:30 pm; 10 pm to 6 am; 7 am to 1 pm.	15.270	WCBW	NEW YORK CITY: European beam, 6 am to 3:45 pm.
11.845		PARIS, FRANCE: 8 to 9:45 pm; 10 to 10:45 pm; 11 to 11:45 pm; mid- night to 3 am; noon to 5 pm; 5:30 to 7:30 pm.	12.265	TFJ	REYKJAVIK, ICELAND: 8 to 9 am; 4:30 pm.	15.270	KCBR	LOS ANGELES, CALIF.: Oriental beam, 4 to 10 pm; 10:15 pm to 1 am.
11.847	WGEA	SCHENECTADY, NEW YORK: Euro- pean beam, 8 am to 3:45 pm; Bra- zilian beam, 4 to 10:30 pm.	12.270	HCJB	HAVANA, CUBA: evenings.	15.280	WNRE	NEW YORK CITY: European beam, 7:30 am to 4:15 pm.
11.847	XMH4	SHANGHAI, CHINA: 6 to 0 am.	12.445	HCJB	QUITO, ECUADOR: afternoons and evenings.	15.290	WRUL	BOSTON, MASS.: North African beam, 9 am to 5 pm; Caribbean beam, 5:15 to 5:45 pm.
11.855		SINGAPORE, MALAYA: 8 to 9:30 am.	13.000	HDD	QUITO, ECUADOR: 2:45 to 3:30 am.	15.275	ZOJ	COLOMBO, CEYLON: news at 10 pm and midnight.
11.860	GSE	LONDON, ENGLAND: Near and Mid- dle East beam, 11:45 pm to 5 am; 1:30 to 2 pm; African beam, 3:30 to 4 pm; European beam, 11:30 to 1:45 am; 5 to 8 am; 10:15 am to 11:30 am; 12 to 4 pm.	13.050	WNRI	NEW YORK CITY: European beam, 6 am to 6 pm.	15.290	VUD3	DELHI, INDIA: 7 to 8 am.
11.860		RANGOON, BURMA: 10 pm to 1 am; 2:15 to 3 am; 8:30 to 10 am.	13.050	KCBR	SAN FRANCISCO, CALIF.: Oriental beam, 10:15 pm to 1 am.	15.300	GWR	LONDON, ENGLAND: South Amer- ican beam, 2:30 to 4:45 pm; Central American beam, 5 to 6:15 am; 2:30 to 4:45 pm.
11.870	WNBI	NEW YORK CITY: South American beam, 6:30 to 11 pm.	14.560	WNRX	NEW YORK CITY: European beam, 6 am to 3:45 pm.	15.310	GSP	LONDON, ENGLAND: North Amer- ican beam, 6:15 am to 6 pm; African beam, 1 to 3 am; Near and Middle East beam, 5:15 to 5:30 am.
11.870	WOOW	NEW YORK CITY: European beam, 6 am to 5:45 pm.	15.000	WVW	WASHINGTON, D. C.: U. S. Bureau of Standards; frequency, time and musical pitch; broadcasts contin- uously day and night.	15.315	HER6	BERNE, SWITZERLAND: Mondays, 3 to 3:30 am.
11.880	LRR	ROSARIO, ARGENTINA: heard at 7:30 pm.	15.070	GWC	LONDON, ENGLAND: Far East beam, 5 to 10:15 am.	15.320	JLP2	MOSCOW, U.S.S.R.: 5 to 11:30 am.
11.885		MOSCOW, U.S.S.R.: 6:45 to 8 am; 6:30 to 7:30 pm.	15.105	GWG	TOKYO, JAPAN: heard at 7:30 pm.	15.325	WGE0	TOKYO, JAPAN: 11:45 pm to 4 am.
11.890	KWIX	SAN FRANCISCO, CALIF.: Hawaiian beam, 4 pm to midnight; 12:15 to 1:45 am.	15.110	GWG	LONDON, ENGLAND: Near and Mid- dle East beam, 6:15 to 6:45 am; 1:30 to 2 pm; African beam, 12:30 to 12:45 pm; European beam, 5 to 8 am; 10:15 am to 2 pm; 2:30 to 4 pm.	15.330	KNBI	SCHENECTADY, NEW YORK: Euro- pean beam, 6 am to 4:30 pm.
11.893	WNBI	NEW YORK CITY: European beam, 1:15 to 4:45 pm.	15.110	HCJB	QUITO, ECUADOR: mornings and afternoons.	15.340	WRUA	SAN FRANCISCO, CALIF.: South American beam, 5 to 11:45 pm; Oriental beam, 2 to 4:45 pm.
11.897	JVU3	TOKYO, JAPAN: 6:45 am to 12:30 pm.	15.130	KGE1	SAN FRANCISCO, CALIF.: Alaska- Oriental beam, 5 to 7:45 pm; South- west Pacific beam, 8 pm to midnight.	15.350	WRUA	BOSTON, MASS.: European beam, 6 am to 4:15 pm.
11.900	XGOY	CHUNGKING, CHINA: Allied forces in the Far East, 7 to 8 pm; Asia, Australia, New Zealand beam, 5 to 5:30 am; East Russia beam, 5:30 to 6 am; Japan beam, 6 to 6:30 am.	15.130	WRUW	BOSTON, MASS.: European beam, 6 am to 4:15 pm.	15.350	GRE	PARIS, FRANCE: 6 to 8 am.
11.900	CXA10	MONTEVIDEO, URUGUAY: 3:30 to 9 pm.	15.140	GSF	LONDON, ENGLAND: Australia beam, 1:30 to 4 am; Indian beam, 11 pm to 12:45 am.	15.375	PZX5	LONDON, ENGLAND.
11.930	GVX	LONDON, ENGLAND: North Amer- ican beam, 5 to 7 am; 2:30 to 4 pm; 4:15 to 9 pm; Indian beam, 10:30 am to 12:15 pm.	15.120	HVJ	VATICAN CITY: Wednesdays, mid- night to 2:30 am.	15.405	GWD	PARAMARIBO, SURINAM: 12:30 to 1 pm.
11.950		MEXICO CITY, MEXICO: heard even- ings.	15.150	WRCA	NEW YORK CITY: European beam, 7:30 am to 3:30 pm; Brazilian beam, 4 to 6:45 pm.	15.420	GWE	LONDON, ENGLAND: Australian beam, 1:30 to 4 am; New Zealand beam, 1:30 to 4 am.
11.955	GVY	LONDON, ENGLAND: European beam, 5 to 7:30 am; Near East beam, 1 to 4 pm.	15.150	KNBX	SAN FRANCISCO, CALIF.: Oriental beam, 9 to 11:45 pm.	15.435	GRD	LONDON, ENGLAND: Middle East beam, 12 to 2:15 pm; South Amer- ican beam, 2:30 to 4:45 pm.
11.960	HEK4	BERNE, SWITZERLAND: Tuesday and Saturday, midnight to 1:30 am.	15.155	SBT	STOCKHOLM, SWEDEN: 6 to 7 am; 10 am to 1:15 pm; Sundays, 2:45 am to 1:15 pm.	15.450	GRD	LONDON, ENGLAND: African beam, 10:30 am to 2:15 pm.
11.970	FZ1	BRAZZAVILLE, FRENCH EQUA- TORIAL AFRICA: 11 am to 6:45 pm; midnight to 2:30 am.	15.160	JZK	TOKYO, JAPAN: heard at 7:30 pm.	15.505	CMA5	HAVANA, CUBA: 6:45 to 7:30 pm.
11.955	CSX	LISBON, PORTUGAL: 8 to 10 am.	15.170	TGWA	GUATEMALA CITY, GUATEMALA: daytime transmissions.	15.595	FZ1	BRAZZAVILLE, FRENCH EQUA- TORIAL AFRICA: 4:15 to 8 am.
12.000	CEI180	SANTIAGO, CHILE: late afternoons.	15.180	GSO	LONDON, ENGLAND: Near East beam, 12:15 am to 3:30 pm.	15.620	VRR6	JAMAICA, BRITISH WEST INDIES.
12.040	GRV	LONDON, ENGLAND: Australian beam, 12 to 4 am.	15.190	CKCX	MONTREAL, CANADA: European beam, 7 am to 3 pm.	15.810	LSL3	BUENOS AIRES, ARGENTINA: heard mornings.
			15.195	TAQ	ANKARA, TURKEY: 4:15 to 8 am.	15.875	HED4	BERNE, SWITZERLAND: 2:15 to 2:50 pm.
			15.200	WLWS1	CINCINNATI, OHIO: South American beam, 5 to 7:15 pm.	15.920	KU5Q	GUAM: 7 pm to midnight.
			15.200	VLA6	MELBOURNE, AUSTRALIA: Japa- nese beam, 2:30 to 3:30 am.	17.445	HVJ	VATICAN CITY: Wednesdays and Saturdays, 8:45 to 9:15 am.
			15.200	WOOC	NEW YORK CITY: European beam, 6 am to 3:15 pm.	17.527	FZ1	BRAZZAVILLE, FRENCH EQUA- TORIAL AFRICA: midnight to 2:30 am; 4:45 to 7:45 am; 11 am to 5 pm.

(Continued on page 660)

## NEW RADIO ELECTRONIC PATENTS

### ANTENNA SYSTEM

George T. Royden, S. Orange, N. J.  
Patent No. 2,393,656

A RHOMBIC ANTENNA is known as an excellent wide-band system. However, it requires a resistance termination for optimum results. This resistor must dissipate sufficient energy to prevent reflection along the antenna.

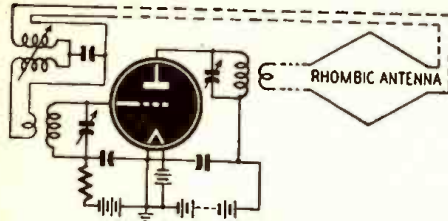

Instead of a resistor, this rhombic uses a transformer as a termination, for the purpose of transmitting some of the antenna energy back into the transmitter input. Therefore two effects are accomplished; antenna reflections are eliminated; oscillations are maintained. The transmission line between antenna output and transmitter input can be made of suitable length so that phase relations are satisfied for oscillations at the required frequency.

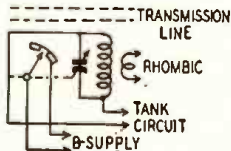

The inventor suggests the use of this system in connection with radar or radio jamming facilities. For these purposes the tuning condenser is rotated continuously through the desired band of frequencies. On the same shaft is connected a rotary arm contacting a metal band. This constitutes the B-minus return. At one position an interruption on the metal band is provided, so that during this moment (corresponding to the desired frequency) no jamming takes place. This frequency, which may be set at any desired point in the band covered by the apparatus, is used for communication transmission.

### PULSE MODULATOR

John E. Gorham, Spring Lake and  
Andrew W. Frevert, S. Belmar, N. J.  
Patent No. 2,391,894

THIS circuit is designed to shape as well as time the pulses used to modulate an r.f. amplifier. An alternating current is rectified and applied to a thyatron control circuit. This voltage charges the condenser at a rate determined by the resistance and capacitance in the circuit. The charging current flowing through R1 puts a negative voltage on the grid which opposes the existing positive voltage, and as it dies down, two effects tend to break down the tube: (a) the rising plate voltage (b) the rising grid voltage. The variable resistor is adjusted to fire the tube at the moment of peak condenser voltage.

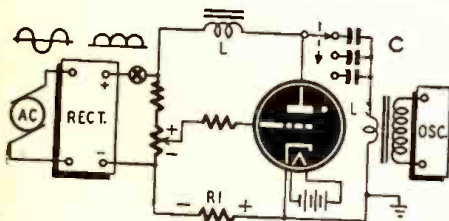

When the tube fires it permits the condenser to discharge through it (L prevents sudden current flow), the resulting oscillatory flow reversing the condenser voltage and quickly extinguishing the tube.

With the rectified voltage shown, the pulse rate will be twice that of the applied a.c. frequency. If pure d.c. is used this rate may be adjusted to any value by changing values of C and L (the transformer primary). The width of the pulse depends upon the size of condenser C.

Built like a fine watch

Yet

**RUGGED AS  
OLD BIG BEN\***

**TURNER MODEL 99  
DYNAMIC**

Engineered for discriminating users who want utmost efficiency and dependability, the Turner Model 99 Dynamic is the most rugged microphone in the entire Turner line. Its precision-built dynamic circuit withstands the extremes of climate and temperature to reproduce sharp and clear under difficult operating conditions. Large city police departments, commercial broadcast studios, and leading manufacturers of communications equipment depend on Turner 99 for unfailing performance. Professional case is finished in rich gun metal and equipped with adjustable saddle for semi- or non-directional operation. Range 40-9,000 cycles. Level — 52DB. Available in all standard impedances and complete with 20 ft. removable cable set.

### TURNER MODEL 999 BALANCED LINE DYNAMIC

The same professional appearance and rugged construction as Model 99 with voice coil and transformer leads insulated from ground and microphone case. Line is balanced to the ground. Especially recommended for critical applications. Range 40-9,000 cycles. Level — 52DB. In all standard impedances with removable 20 ft. balanced line, low capacity cable set.

Ask your dealer or write for full specifications

\*The famous clock of London

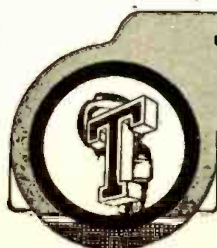

**The TURNER Company**

TURNER — Pioneers in the Communications Field

902 17th Street N.E., Cedar Rapids, Iowa

Licensed Under U. S. Patents of the American Telephone and Telegraph Company, and Western Electric Company, Incorporated.

# NEW

# RADIO-ELECTRONIC DEVICES

## SOUND PRESSURE METER

Massa Laboratories  
Cleveland, Ohio

The Massa Model M 101 Sound Pressure Measurement Standard is a precision acoustic instrument developed for making absolute sound pressure measurements throughout the range.

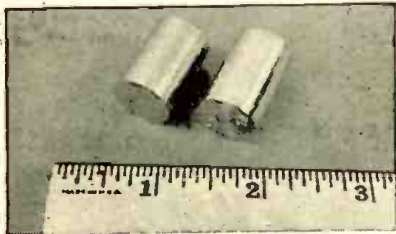

Specifications: Physical Size: 5/8-inch diameter cylinder by 15/16-inch long. Outer Housing: Metallic, chrome plated, electrically independent from both terminal connections. Electrical Connection: Two insulated pins projecting through bottom. Acoustic Impedance: Greater than 0.001 c.c. of air. Resonant Frequency: Above 45 kc, resulting in absolutely uniform pressure sensitivity throughout the audible frequency range. Free Field Response: Non-directional in all planes to 5 kc. Diffraction presented by a rigid cylinder 5/8-inch diameter at higher frequencies. Cavity Resonance: Completely eliminated in the design. Sensitivity: 23 microvolts/dyne/cm<sup>2</sup> sound pressure. Electrical Impedance: Equivalent to a 100 µf condenser throughout the entire audible range.—RADIO-CRAFT

## TUBE TESTER

Hickock Electrical Instrument Co.  
Cleveland, Ohio.

The Model 532C (counter model) and 532P (portable) accurately test and reject all bad tubes. The tester is fitted with scales having MICROMHO ranges



from 0-3000, 0-6000, 0-15,000 with legends indicating "Replace," "Doubtful," and "Good." This unit also provides for noise, gas, and hot and cold shorts tests. Diodes are tested separately with low voltage to prevent paralysis of the elements. Line voltage is indicated correctly on a large test meter—from 100 to 130 volts. Rectified current is used to energize plates and grids, using two

rectifiers, and tests can be made of grid controlled rectifier tubes. Filament voltage is in steps to 117 volts. The tester is 17x18x8 1/2-inches in size and operates on a power supply of 110-130 volts from 50-60 cycles. Tube complement is one type 83 and one type 5Y3-GT. Tests of all present-day tubes, including Octal, Loktal, Miniature, Ballast and Magic Eye tubes, can be made and provision has been made for future tube designs.—RADIO-CRAFT

## INTERCOMMUNICATOR

Operadio Manufacturing Co.  
St. Charles, Illinois

The new Flexifone line features a 10-station master, a 20-station master, a 6-station "Supervisor" master, and remote speaker station.

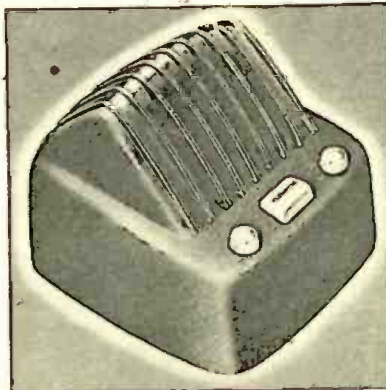

Outstanding features are modern housings of durable die-cast metal; attractive gray-tan Hammerloid finish; self-clearing, gravity-assisted piano-type keyboard for station selector switches; selector keys and controls of plastic.—RADIO-CRAFT

## COMMUNICATIONS RECEIVER

Hallicrafters Co.  
Chicago, Illinois

The S-40 communications receiver features standard broadcast as well as short wave, using red markings for b.c. band. Selection of standard broadcast is thus made so simple that a child can operate it. Frequency ranges from 550 kc to 44 mc are covered in four bands. A nine-tube set, the S-40 is designed primarily for radio amateurs and short-wave listeners, but is also adapted to general use. An external "S" meter which can be connected through a special socket on the rear of the chassis is available as an accessory.—RADIO-CRAFT



## AMATEUR CRYSTAL

Bliley Electric Co.  
Erie, Penna.

This new crystal, Type AX2, features primary electrodes consisting of a micro-thin metal film deposited directly on the major crystal surfaces by evaporation under high vacuum. Secondary

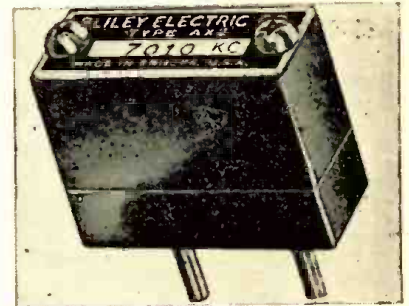

electrodes, under spring pressure, clamp the crystal and provide necessary thermal dissipation. This design results in better grid current stability over a wide temperature range, improved frequency stability under high drive conditions and substantial improvement in keying characteristics.—RADIO-CRAFT

## STUDIO RECORDER

Fairchild Camera and Instrument Co.  
Jamaica, N. Y.

The No. 523 studio recorder is designed to meet the requirements of the commercial recording and radio industry for instantaneous or wax recordings; and the sound film industry for dubbing sound from disk to film. The table accommodates 18-inch flowed wax masters, acetate, or thicker wax masters. The synchronous motor 33.3 r.p.m. drive

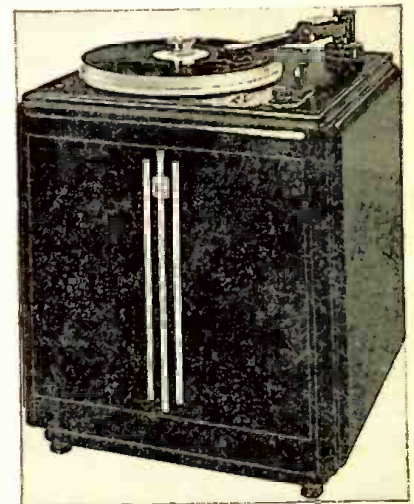

guarantees absolute timing, also making the a.c. line the only interlocking device needed for dubbing sound. No. 541 magnetic cutterhead, microscope and mount in combination with the precision-built lead screw mechanism assures uniform cutting at any pitch from 80 to 160 lines.—RADIO-CRAFT

# LORAN BY SPERRY

03617  
TIME DIFFERENCE

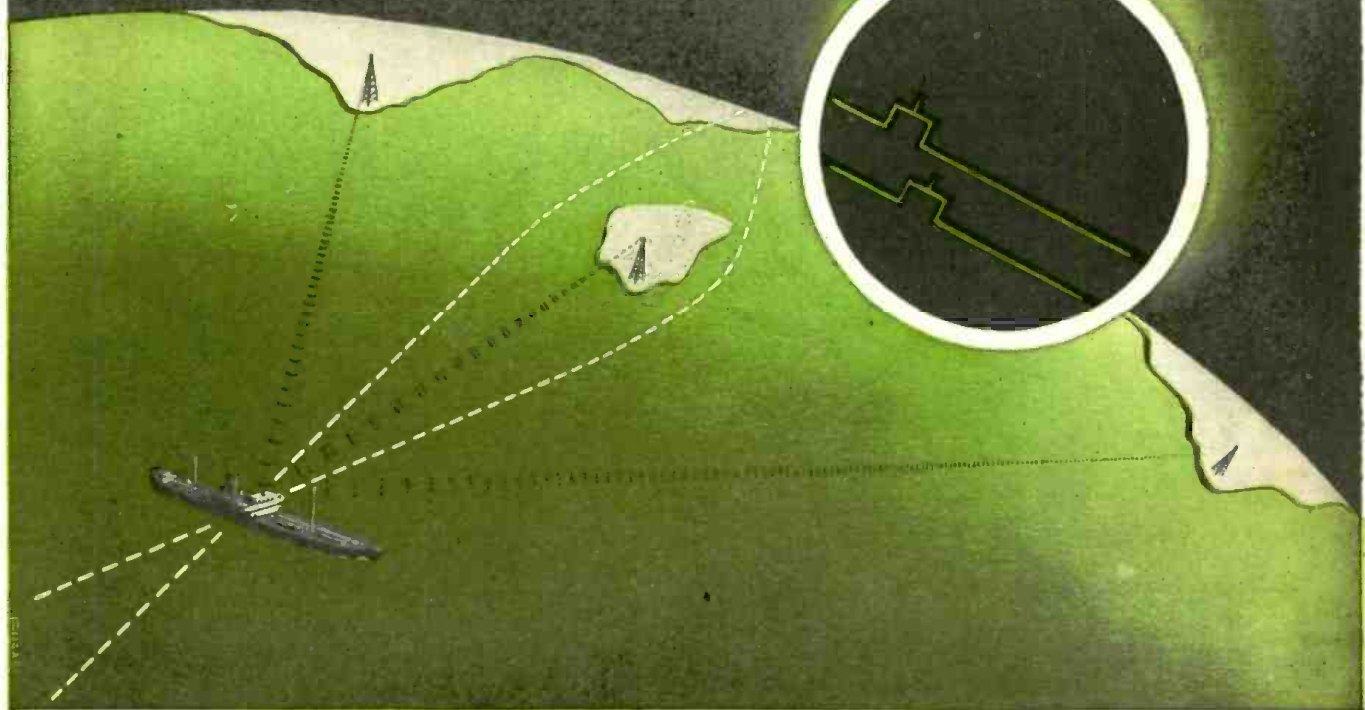

## Accurate **LONG RANGE** Navigation... anytime... in all weather

With Sperry Loran the navigator has at hand a quick and accurate means of determining a ship's position at any time, in all kinds of weather. This system involves the reception of accurately timed radio pulses from shore-based transmitting stations, usually 200 to 400 miles apart.

The difference in time of arrival of signals from a pair of transmitting stations is measured and the time difference is then used to determine, from special charts or tables, a line-of-position on the earth's surface. When two lines-of-position from two different pairs of Loran stations are

RADIO-CRAFT for JUNE, 1946

crossed, you have a "Loran fix." Fixes are obtainable at distances from shore stations up to 1400 miles at night, 700 miles in daytime.

In your consideration of Loran, note particularly that Sperry's equipment is easy to operate. A Time Difference Meter (see illustration above) greatly simplifies the operator's

work and prevents errors in readings.

Sperry Loran is backed by a worldwide service organization and meets the usual high standards of test and performance of all Sperry products. *Loran equipments in limited quantity are ready for immediate delivery.*

*\*The Time Difference Meter, giving position references directly, is a Sperry exclusive.*



## Sperry Gyroscope Company, Inc.

EXECUTIVE OFFICES: GREAT NECK, NEW YORK • DIVISION OF THE SPERRY CORPORATION  
LOS ANGELES • SAN FRANCISCO • NEW ORLEANS • HONOLULU • CLEVELAND • SEATTLE  
GYROSCOPICS • ELECTRONICS • RADAR • AUTOMATIC COMPUTATION • SERVO-MECHANISMS

*timely!  
authentic!  
comprehensive!*



## Save Up to 50% in Servicing Time!

### In Each PHOTOFACT FOLDER You Get:

- ✓ From 2 to 12 clear photos of the chassis, identifying each component part for immediate checking or replacement.
- ✓ Complete specifications on each component, including manufacturer's part number, available replacement type or types and valuable installation notes.
- ✓ A keyed reference alignment procedure for the individual set, with adjustment frequencies and recommended standard connections.
- ✓ Complete voltage analysis of receiver.
- ✓ Complete resistance analysis of receiver.
- ✓ Complete stage gain measurement data.
- ✓ Schematic diagram.

**MAIL THIS  
COUPON  
TODAY**

If you think it's going to be easy to service the 1,000 or more radio sets soon to come off production lines, read no further! The Howard W. Sams PhotoFact Service is designed for men who *know* there's a tough time ahead—who need and *want* better service information.

The Sams PhotoFact Service provides such information in the form of reliable, fact-filled, illustrated folders that can save as much as 50% of your servicing time. Every post-war radio is visualized in photographs . . . every part listed and numbered . . . every servicing shortcut and installation fact fully set down! No matter how complicated the set, or how new the components, you have the whole story right in front of you.

You get from 30 to 50 such PhotoFact Folders at a time. The Folders come to

you in handy folios at a cost of only \$1.50 for each group! They cover all new sets as they reach the market.

Think of it! An absolutely fool-proof visual method of giving you the exact information you want, where you want it, when you want it, for as little as three cents per new radio model! And every bit of information is compiled by experts from an examination of the actual receiver itself—*not from standard service data!* The Howard W. Sams PhotoFact Service starts June 15. Reserve your PhotoFact service now!

### Also, Membership in HOWARD W. SAMS INSTITUTE

Answers to hard service problems! Economical shop practices! How to get more customers! These and many other subjects covered by 30 top notch specialists! Complete facts with PhotoFact Folio No. 1.

Cut This Out and Mail It to Your Distributor! If you do not know his name and address, send it directly to Howard W. Sams & Co., Inc. 2924 East Washington Street, Indianapolis 6, Indiana, and we will see that your nearest distributor gets it.

CHECK ONE SQUARE

PLEASE PRINT

- Yes, by all means reserve every issue of the Howard W. Sams PhotoFact Folio Service for me.
- Send complete information and reservation card.
- My (check) (money order) (cash) for \$1.50 is enclosed for PhotoFact Folio No. 1. (Publication date, June 15, 1946)

Name \_\_\_\_\_ Address \_\_\_\_\_

City \_\_\_\_\_ Zone \_\_\_\_\_ State \_\_\_\_\_

Company Name \_\_\_\_\_

My Distributor's Name \_\_\_\_\_ City \_\_\_\_\_

*Howard W. Sams*

**Radio PhotoFact Service**



# CALRAD "Hard-to-get" RADIO VALUES!

## Auto ANTENNAS

- 3 Section
- 66" Long
- Brass Tubing
- Triple Chromium Plated
- 2 Insulator Type Cowl Mounting with Lead Individually Boxed

24 to Master Carton

**\$30**

Lots of 96

**\$105**

IMMEDIATE DELIVERY BUT QUANTITY IS LIMITED

## 5 TUBE SUPERHET AC-DC PARTS KIT

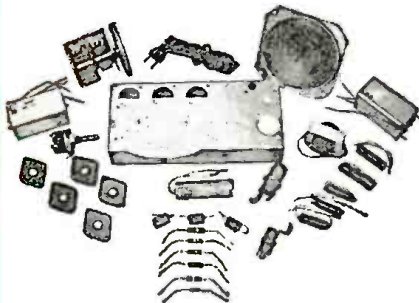

These Special Kits include: Stamped Chassis-Dynamic Speakers, Output Transformer, Volume Control and Switch, 2 Shielded I.F. Coils, Antenna and Osc. Coils, Two-gang Super Variable, 5 Octal Sockets, 20 x 20 Mfd. 150-Volt Filter, 5 Tubular Condensers, 3 Mica Condensers, 6 Resistors, 6 ft. A.C. Cord and Plug, Circuit Diagram.

**WHILE THEY LAST \$8.95 each**

(Lots of 6—\$50.00)

## SIGNAL CORPS TELEGRAPH KEYS



Genuine U.S. Signal Corps telegraph keys brought to you at prices below manufacturing costs. Made with switch to close contacts, polished durable enameled metal base mounted on a bakelite base; key lever is nickel-plated; contacts are brass-silver.

Packed in new original boxes.  
Lots of 10      Carton of 50

**75¢** ea.

**60¢** ea.

## MICROMETER

Western Electric—0-200 Microamps D.C. — Zero adjustment, — Bakelite Case — 3-inch meter — Individually boxed.



**\$3.95** Each

## V.M. TWO POST AUTOMATIC RECORD CHANGER



Carton of 2 **\$38.00**

This Record Changer is a well-made mechanism, will play either 10-in. or 12-in. records. The pickup uses a crystal cartridge. Size 14 in. x 14 in. Packed 2 to a factory-sealed carton, factory guaranteed.

Special \$20.95 each

## Approved SIGNAL GENERATOR Model A-100

A—100 to 310 Kilocycles  
B—320 to 1000 Kilocycles  
C—1000 to 3200 Kilocycles  
D—3.2 to 10.5 Megacycles  
E—10.5 to 26 Megacycles  
E2—21 to 52 Megacycles  
440 Standard Audio Frequency (same as WWV). Internal modulation at 440 cycles (same as WWV). External modulation possible from 40 to 30,000 cycles. Complete

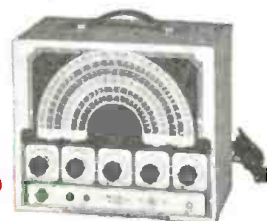

**\$47.00**

**BUY NOW! LOWEST PRICES! STOCKS LIMITED!**

### GUARANTEED FILTER CONDENSERS (TUBULAR TYPE)

10 mfd. 50 Vo.	\$21.00 per 100
16 mfd. 150 Vo.	\$25.00 per 100
20 mfd. 150 Vo.	\$28.00 per 100
30 mfd. 150 Vo.	\$30.00 per 100
50 mfd. 150 Vo.	\$33.00 per 100
20x20 mfd. 150 Vo.	\$39.00 per 100
30x20 mfd. 150 Vo.	\$45.00 per 100
40x20 mfd. 150 Vo.	\$50.00 per 100
50x30 mfd. 150 Vo.	\$55.00 per 100
Standard Brands, Tubular By Pass Condensers .001—.002—.003—.005—.006—600 Volt	\$6.75 per 100
.025—.01—.02—600 Volt	\$ 7.75 per 100
.05—600 Volt	\$ 9.75 per 100
1—600 Volt	\$12.00 per 100
.25—600 Volt	\$18.00 per 100
5—600 Volt	\$22.00 per 100
4 mfd. 600 Vo. T.L.A. Oil Condenser, screw base, upright aluminum can, 1 1/2"x3 3/4" In. \$4.50 list. replaces 8 mfd. 600 Vo. electrolytic.	
Carton of 40	\$38.50

### SPEAKERS

4 in. 450 ohm Dynamic Speaker Packed 30 to factory carton.....\$1.70 ea.

4 in. P.M. Speaker Alnico V slug Packed 30 to factory carton.....	\$1.65 ea.
5 in. P.M. Speaker Alnico V slug Packed 30 to carton.....	\$1.70 ea.
5 in. 450 ohm Dynamic Speaker Packed 20 to carton.....	\$1.75 ea.
6 in. P.M. Speaker, Heavy Slug Packed 20 to carton.....	\$1.95 ea.
Rubber Sheathed "Mike" Cable, shielded, single Conductor.....	100 ft. for \$ 5.95 500 ft. for \$25.00
456 K.C. Antenna, Oscillator and R.F. Coils.....	25c ea.
456 K.C. I.F. Coils Input & Output, medium size can.....	\$45.00 per 100 asst.
6 ft. A.C. Cords with plug.....	\$20.00 per 100
Astatic Low Pressure, curved arm, crystal pickup with Sapphire Stylus Permanent Needle, has cartridge which replaces LP6-LP21-LP23.....	\$3.75 ea. Lots of 10—\$33.50
Standard Low Pressure Crystal Pickup.....	\$2.50 ea.—Lots of 10—\$22.50

### SIGNAL CORPS JACKS

Fits all standard plugs. Open circuit, Mallory type SC-1 equivalent of Signal Corps Jack No. JK 34A.....\$12.00 per 100  
\$100 per 1000  
Volume Controls, less Switch—1 1/2" shaft, 250,000 ohm.

1 Meg	Lots of 100
2 Meg	\$27.50
Kit of 50 assorted Bakelite Knobs for 1/4 in. shaft, with set screws.....	\$2.50 per kit
2000 ft. Spool No. 16 Solid Push Back Wire.....	\$9.00 per spool
Standard Barrel Type Phone plug.....	\$20.00 per 100
Midget Ceramio Trimmer—3-30 mmf.....	\$6.00 per 100
Moulded Octal Sockets 1/2 in. mtg with metal ring.....	\$7.00 per 100
Mazda Pilot Bulbs No. 44 Packed 10 to box.....	\$4.25 per 100
1000 to Carton.....	\$38.50 per 1000
No. 40 and 46 packed 100 to carton.....	\$4.25 per 100
Single Pentode Midget Output Transformers for 50L6—25Z6—etc.....	Lots of 25—55c ea.
Insulated Banana Plugs, solderless, side screw connection, red or black.....	\$10.00 per 100
Insulated Banana Tip Jacks, red or black.....	\$8.50 per 100
Finest Quality Midget Micars:	
.001—.0001.....	\$5.00 per 100
.002—.00025.....	
.005—.0005.....	
.006—.005.....	
Tinned Copper Shielding.....	\$1.50 per 100 ft.
1/2 in.—1/4 in. 3/4 in. per 100 ft.	
Filter Choke, 75 Mill.—250 ohms—3/4 in. Core, 85c ea.	
Filter Choke—50 mill.—300 ohms—3/4 in. Core. .65c ea.	

MAIL ORDERS FILLED: 25% deposit with order, balance C. O. D. References—Bank of America, Santa Monica & Vermont Avenues Los Angeles, California

**CALIFORNIA RADIO & ELECTRONICS CO.**  
DEPT. NO. C 7-11 NO. VERMONT AVE., LOS ANGELES 27, CALIFORNIA

# WATTAGE FROM OHMS AND AMPS

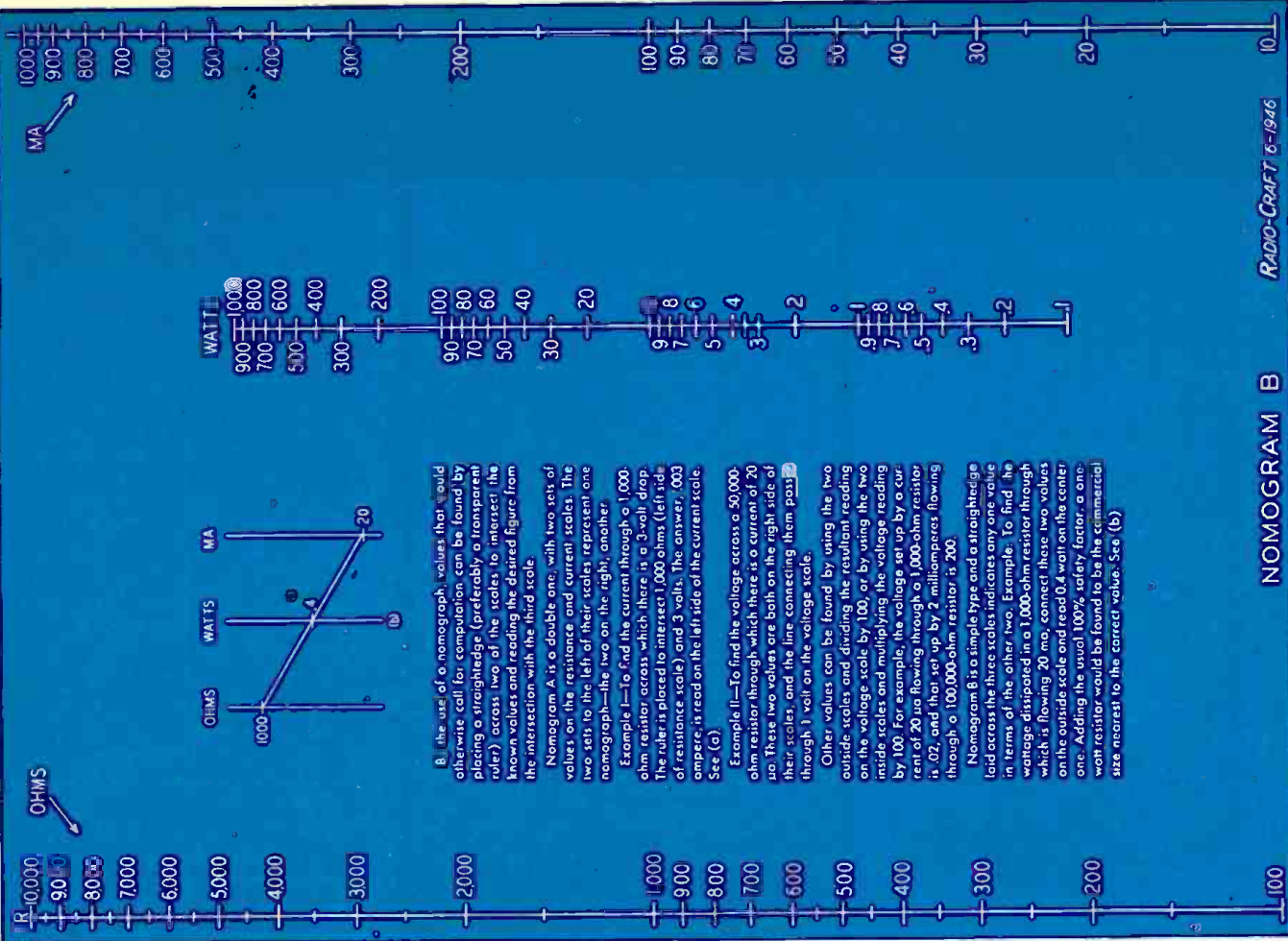

RADIO-CRAFT 6-1946  
NOMOGRAM B

# OHM'S LAW IN GRAPH FORM

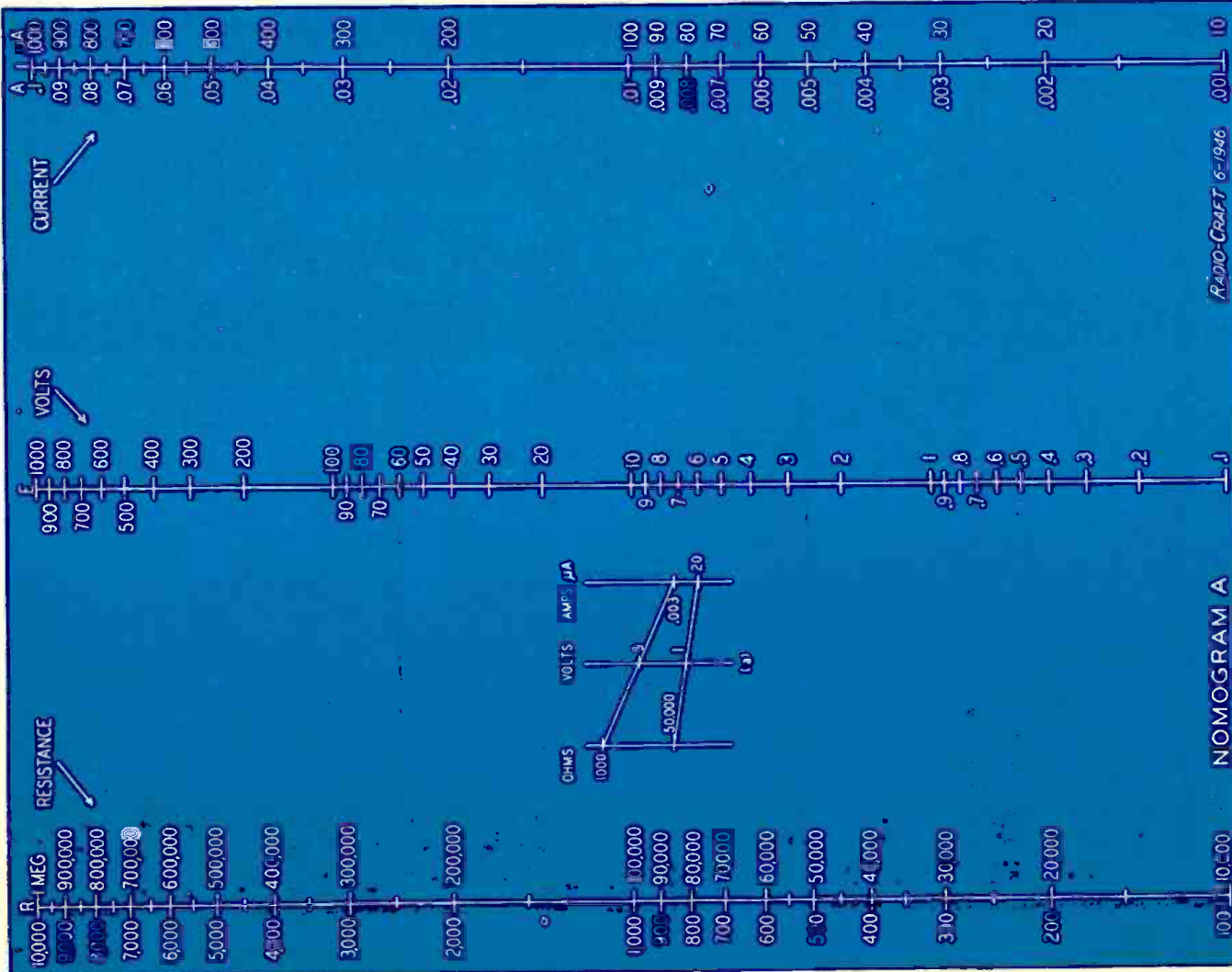

RADIO-CRAFT 6-1946  
NOMOGRAM A

**NOMOGRAPH CONSTRUCTION**  
(Continued from page 609)

In Nomogram A, (shown on opposite page), one of the ranges (figures to the right of the scale lines) is 10 microamperes to one milliamper (1/100,000 to 1/1,000 ampere) and 10,000 ohms to 1 megohm. The other range (figures to the left of the scale lines) is from 1 milliamper to 0.1 ampere and from 100 to 10,000 ohms.

Since our outside scales range from 1 to 100, the center voltage scale might be expected to start with 1 (1 × 1) and end with 10,000 (100 × 100). But the two outside scales in this nomogram have been intentionally started with numbers which have a product of 0.1 volt. At the top we have 1 megohm × 1 ma and 10,000 ohms × 0.1 ampere = 1,000 volts in each case. How is the center

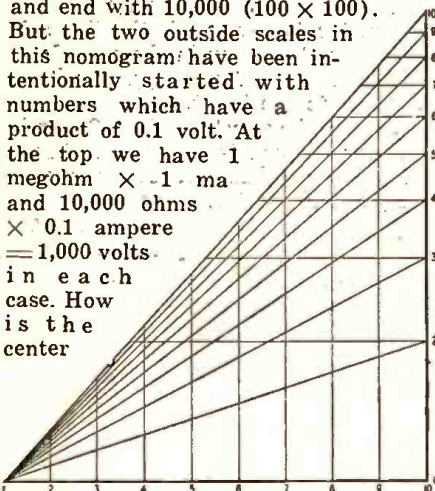

Fig. 3—With this guide (on 10- or 20-inch paper) nomograms may be drawn to any scale.

scale to be constructed? Four-cycle paper is not easily obtained—if at all—in our small size, and the center scale has four cycles.

The device in Fig. 3 solves the problem. This is drawn on 1-cycle paper (or can be drawn on any piece of paper more than 10 inches square with the help of a slide-rule scale). The base is divided into 10 equal parts from 1 to 10 (conveniently 1 inch apart). The altitude is divided logarithmically according to the 1-cycle paper (or the C-scale of a slide-rule). (Much log paper comes seven inches wide and it may be necessary to paste two sheets together, but carefully!) We can make logarithmic scales of any length with this diagonal figure.

To use the diagonal guide on the 4-cycle voltage scale, mark out the 10-volt and 100-volt points on the nomogram. One milliamper × 10,000 ohms = 10 volts. Since these figures appear on both scales, it is necessary only to connect the values together with the usual straightedge, marking the point where it crosses the center line. The two marks should coincide at the 10-volt point. Locate the 100-volt point with 10,000 ohms × .001 ampere and 1,000 ohms × 0.1 ampere, and the 1-volt point with 100,000 ohms × 10 μa and 100 ohms × .01 ampere.

Insert the diagonal guide under the tracing paper, keep its base line directly under the base line of the nomogram,  
(Continued on page 631)

# Highest Quality RADIO and ELECTRONIC Testing Equipment

**Immediate Delivery from Stock Guaranteed**

**The New Superior  
Model CA-11  
Signal Tracer**  
Net Price \$18.75



- FEATURES:**
- \* Signal intensity readings are indicated directly on the meter.
  - \* Only one connecting cable—No tuning controls.
  - \* Highly sensitive—uses an improved vacuum tube voltmeter circuit.
  - \* Tube and resistor-capacity network are built into the Detector Probe.
  - \* Completely portable — weighs 5 lbs. Measures 5 x 6 x 7 inches.
  - \* Provision is made for insertion of phones.

**The New McMurdo  
Silver Model 904  
Capacitance  
Resistance  
Bridge**  
Net Price \$49.90



1/2 mfd/ohm thru 1,000 mfd./megohms; 0-50% power factor; 0-500 volt adjustable internal polarizing voltage; 0-10 and 0-100 ma. electron-ray leakage current meter; measures resistance, capacitance under actual operating voltages!

**The New Model 802N  
Combination  
TUBE & SET  
TESTER**  
Net Price \$58.31

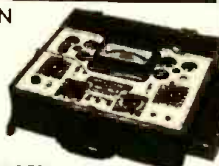

**RANGES:**  
DC Voltmeter: 0/10/50/300/1000 at 1000 ohms per volt  
Four Range AC Voltmeter: 0/10/50/300/1000  
DC Milliammeter: 0/1/10/1000 DC Ammeter 0/10  
DB Meter: -8/15/15 to 29/29/ to 49/32 to 55 decibels  
Four Range Output Meter—same as AC Volts

**The  
New SUPERIOR  
Model 400  
Electronic  
Multi-Meter**  
Net Price \$52.50

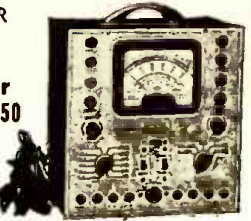

**RANGES:**  
DC V.T.M. Volts: 0 to 3/15/30/75/150/300/750/1500/3000 volts.  
AC Volts: (at 1000 ohms per volt) 0 to 3/15/30/75/150/300/750/1500/3000 volts.  
DC Current: 0 to 3/15/30/75/150/300/750 Ma. 0 to 3/15 amps.  
Resistance: 0 to 1,000/10,000/100,000 ohms. 0 to 1/10/1,000 megohms.  
Capacity: .0005-2 .05-20 .05-20mfd.  
Reactance: 10 to 5M ohms 100-500 ohms .01-5 mers.  
Inductance: .035-14 .35-140 35-14,000 henries  
Decibels: -10 to +18 +10 to +38 +30 to +58.

R.C.P. Model 448 Pocket Multitester	\$ 24.01
R.C.P. Model 424 Volt-Ohm-Milliammeter	\$ 28.91
R.C.P. Model 461A Sensitive Multitester	\$ 36.71
R.C.P. Model 664 Electronic Voltmeter	\$ 45.00
R.C.P. Model 705 Signal Generator	\$ 48.51
R.C.P. Model 486A Ultra-Sensitive Multi-tester	\$ 70.07
R.C.P. Model 805 Tube and Set Tester	\$ 87.71
R.C.P. Model 654 V.T. Volt Ohmmeter	\$ 92.61
Insulation Testers	\$ 95.00
Reiner Model 530 Squarewave Generator	\$ 135.00
Reiner Model 450 Vacuum Tube Volt-Ohm-Milliammeter	\$ 135.00
Superior Model 1553 Volt Ohm Milliammeter	\$ 24.75
Superior Model PB-100 Volt Ohm Milliammeter	\$ 28.40

**The New Model 680  
5000 Ohms Per  
Volt  
VOLT-OHM  
MILLIAMMETER**



Net Price \$27.65  
D.C. Voltages to—1500 volts.  
A.C. Voltages to—1500 volts.  
Resistance to—2 Megohms. Output Volts to—1500 volts. D.C. Current to—150 Ma. Decibels to—+58 D.C.



**The New McMurdo  
Silver Model  
"VOMAX"  
Vacuum Tube  
Voltmeter**  
Net Price \$59.85

D.C. Volts at 51 and 126 megohms, A.C. and r.f. volts at 6.6 megohms. Resistance 2 ohms to 2,000 megohms. D.C. current 1.2 ma. through 12 amperes. D.B. —10 through +50. Plus visual dynamic signal tracing.

**The New Model 668  
Vacuum Tube  
Volt Ohm  
Capacity Meter**  
Net Price \$73.01



**Ranges:**  
D.C. Vacuum-Tube Voltmeter: Direct Reading. Sensitivity: 160 to 16 megohms. Six ranges: 0-6-30-150-600-1500-6000 volts. Voltmeter readings can be taken without affecting circuit constants. A.C. Vacuum-Tube Ohmmeter: Direct reading. Input capacity: 0.00005 mfd. at terminals of instrument. Input resistance: 160 to 16 megohms. Seven ranges: 0-3-6-30-150-600-1500-6000 volts. Measures signal and output voltages from 10 cbs to 10,000 cbs. Vacuum-Tube Ohmmeter: Direct reading. from 0.1 ohm to 1,000 megohms. Seven ranges: 0-1,000-10,000-100,000 ohms 1-10-100-1,000 megohms. Capacity Meters: Accurate measurements from 0.00005 to 2,000 mfd. Seven ranges: 0-0.002-0.02-0.2-2-20-200-2,000 mfd.

**The  
New "MONITOR"  
Crystalizer  
SIGNAL  
GENERATOR**  
Net Price \$57.50



A New Type Signal Generator designed for the Serviceman interested in money-making ideas. Finger-Tip Control. Frequency instantly selected. No confused dial to read. No band switch. I.F., Broadcast, Shortwave and Ultra High Frequencies with or without 400 cycle note. Frequency accurate to .1 or 1%. Output approximately 10 volts.

Superior Model 450 Tube Tester	\$ 39.50
Superior Model 650 Signal Generator	\$ 48.75
Superior Model 720 Multi-Range AC Ammeter	\$ 49.50
Superior Model 600 Combination Tube and Set Tester	\$ 62.50
SHALLCROSS Decade Resistance Boxes	\$ 13.50
SHALLCROSS Portable Galvanometers	\$ 27.50
SHALLCROSS Model 630 Wheatstone Bridge	\$ 75.00
SHALLCROSS Model 637 Kelvin-Wheatstone Bridge	\$100.00
SHALLCROSS Model 638-2 Kelvin Wheatstone Bridge	\$120.00
VM-Model 200-B Record Changer	net \$ 22.50
List Price: \$37.50	
Maguire ARC-1 Record Changer	net \$ 27.50
List Price: \$47.41	

Write for our FREE New POST-WAR CATALOGUE!

**Metropolitan ELECTRONIC & INSTRUMENT CO.**  
Dept. G., 6 MURRAY STREET  
NEW YORK 7, N. Y., U. S. A.  
Cable Address: METRONICS  
Phone: BARclay 7-5556

# RADIO • ELECTRONIC CIRCUITS

## HOME BROADCASTER

A radio receiver may be used as a home broadcaster, at will, by the addition of a single switch.

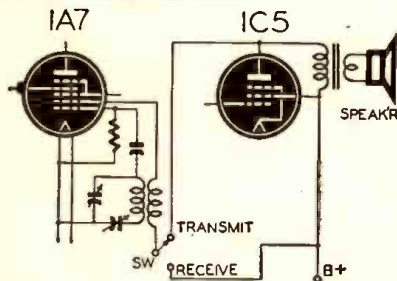

As shown in the circuit, the positive lead to the oscillator tickler coil is broken and the arm of a single-pole double-throw inserted. One of the points of the switch is connected to the plate of the power output tube and the other to the B-plus line. When the switch is in the TRANSMIT position, the oscillator anode (Grid No. 2) may be modulated by speaking directly into the loudspeaker. The broadcaster may be tuned to the desired frequency by using the frequency control dial.

Normal receiver operation is had by throwing the switch to RECEIVE.

GILBERT RUST,  
Evanston, Ind.

(Note—Obviously, this set will not work if the oscillator is isolated from the antenna by a tuned r.f. stage. For best results, the set should have an antenna that is closely coupled to the oscillator. A loop antenna is probably best. It would also seem that if a d.p.d.t. switch were used and the plate of the output tube cut out in TRANSMIT position, results would be better. As it is now, the two tubes are in parallel, resulting in loss of audio energy and heavy transformer primary current.—Editor)

## R-C-L BRIDGE

Here is a very handy piece of equipment that can be constructed quite compactly yet may have the precision of a larger laboratory model. In this circuit, we find the bridge method of comparing known against unknown values and reading the ratio of the bridge.

Balance is indicated by minimum shadow on the eye of the 6AB5/6N5 indicator tube. The condition of balance

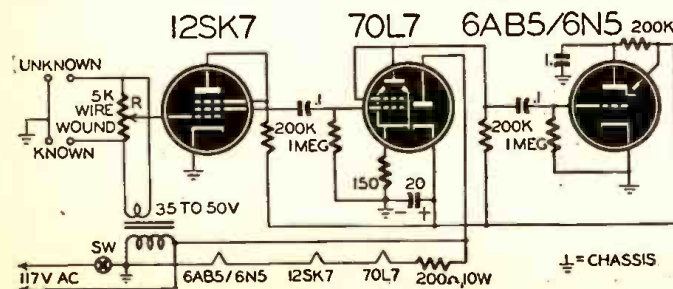

is extremely sensitive due to the high degree of amplification furnished by the 12SK7 plus that of the pentode section, of the 70L7.

Direct current necessary for the operation of the amplifier and indicator sections of the set is furnished by the rectifier section of the 70L7 and the bridge is fed with an alternating voltage having a value from 30 to 50 volts. This voltage may be supplied by re-winding an output transformer. The 5,000-ohm wire-wound resistor in the circuit is the ratio arm of the bridge. It should have a linear taper.

**RADIO-CRAFT** welcomes new and original radio or electronic circuits. Hook-ups which show no advance on or advantages over previously published circuits are not interesting to us. Send in your latest hook-ups—RADIO-CRAFT will extend a one-year subscription for each one accepted. Pencil diagrams—with short descriptions of the circuit—will be acceptable, but must be clearly drawn on a good-sized sheet.

To calibrate the bridge, it is necessary to have a number of standard resistors, capacitors and inductors. These are placed across the KNOWN posts and the unknown value is connected across the UNKNOWN post. The dial of the potentiometer is calibrated from 0 to 100 and if linear will balance at 50 if known and unknown are equal. After the standards have been selected it is possible to calibrate the dial directly by placing other known values across the UNKNOWN posts and noting the position of the potentiometer R when the bridge is balanced.

Calibrating condensers should be of high quality and have a low power factor.

CAPT. DALE W. COURTER,  
Hamilton Field, Calif.

## VACUUM TUBE VOLTMETER

A very good vacuum tube voltmeter may be constructed from a high range d.c. ammeter.

The shunt is removed from across the terminals of a Westinghouse 15-ampere d.c. meter. The meter is inserted in the output circuit of a balanced bridge amplifier using two 6L6 tubes. V3 is the actual metering tube and V4 is

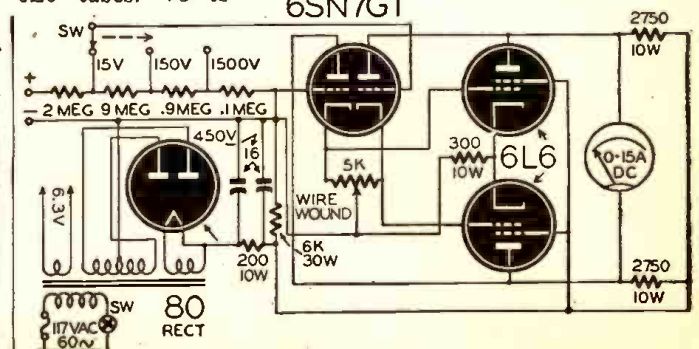

used to balance out any variations in the plate current of V3 which may be caused by grid or line voltage variations.

The 6SN7-GT is used as a cathode-follower amplifier to isolate the grid of V3 from the voltage range resistors and to prevent changes in grid resistance for each range. V2 is the balancing section of the cathode follower.

Calibration is obtained by adjusting the meter to zero with the 5,000-ohm wire-wound resistor in the cathode circuit of the 6SN7 and applying known voltages to the input.

Care in the selection of the 2-megohm resistor for the 15-volt range will result in accurate calibration over the entire range of the meter.

LEONARD W. NORRIS,  
Liverpool, N. Y.

## DIODE OSCILLATOR

For the sake of amusement, the writer suggested the use of the diode tube as an oscillator to a group of radio engineers. Here we are using the term "diode tube" rather loosely. The tube for this circuit is a type 6H6 metal tube, not a 6H6-G or 6H6-GT.

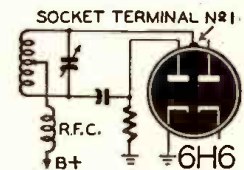

Examining the circuit, you will find that the tube is actually used as a triode. The outer metal shell of the tube is used as a plate and one of the diode plates acts as a control grid. The circuit is quite tricky and may require a little coaxing to produce oscillations.

LEO G. SANDS,  
Towson, Maryland

(The circuit is interesting, but so far does not appear to have any practical angles. But has Mr. Sands tried to magnetize the shell of his tube and use it as a magnetron? Who knows—he may have a new high-frequency circuit!—Editor)

Tube designations were left out of the diagram below. V2 is the left-hand section of the 6SN7, V3 the bottom and V4 the top 6L6.

## 6SN7GT

## NOMOGRAPH CONSTRUCTION

(Continued from page 629)

and slide it left till the diagonal line representing 10 coincides with the 1-volt mark on the voltage scale. The cross lines from 2 to 9—representing tenths of a volt—can now be marked off. Move the guide up and mark the scale from 1 to 10, from 10 to 100 and from 100 to 1,000 in the same way.

This nomogram can be used for any problem where two of the quantities given on the chart are known and the third one is to be found. It has range enough to cover most radio needs, but can be extended still further by using the right side of one outside scale against the left side of the other, multiplying or dividing the middle scale by the appropriate number.

### MORE DIFFICULT PROBLEMS

Most nomograms express more complex problems than the simple  $IR = E$  just described. A common radio problem is: "With a given amount of current through (or voltage across) a resistor, what is a safe wattage rating?" The mathematical formula is  $I^2R = W$  (watts). The difference between this and  $IR = E$  is that we have a *power* of a number to contend with.  $I^2$  cannot be handled like simple  $I$ , but is easy to deal with on a nomographic chart. Multiplication is expressed logarithmically on the chart by simple addition. Powers are expressed by multiplication. The scale for  $I^2$  is simply  $I \times 2$ , or twice as long as a scale for  $I$  would be.  $I^2$  would be four times as long.

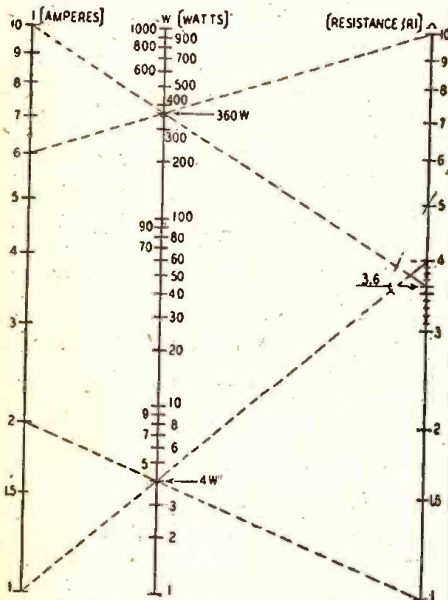

Fig. 4—Placing the "product" scale in graphs which employ roots or powers of the factors.

Nomograms can be constructed with scales of different lengths, but are clumsy. There is another way out of the difficulty. Let us lay out a simple nomogram on 1-cycle paper (Fig. 4), with  $I$  and  $R$  both running from 1 to 10, in amperes and ohms or any multiple or submultiple. The bottom figure for watt-

(Continued on page 633)

## Mr. Radioman—

*What are  
your  
Qualifications?*

**EMPLOYERS ARE CHOOSEY!**



CIRE HOME STUDY COURSES COVER THE FIELD OF RADIO-ELECTRONICS—TELEVISION, ULTRA-HIGH FREQUENCY TECHNIQUES, AM AND FM BROADCASTING, COMMUNICATION ENGINEERING—from simple treatment of fundamentals, through preparation for FCC commercial radio operators' license examinations, up to and including complete high-level quantitative treatment of advanced radio-electronics and communication engineering.

THIS NEW WORLD OF ELECTRONICS promises exciting opportunities for employment in new applications of new electronic developments. FM broadcasting, micro-wave relay systems, television, mobile communication systems for railroads, automobiles, busses, and trucks—these are only a few of the post-war possibilities for new employment. BRAND NEW JOBS IN BRAND NEW FIELDS!

WHAT ARE YOUR QUALIFICATIONS FOR THESE JOBS? That is the first question you will face. Practical experience is only a partial answer—the field has a sufficiency of such men. Practical experience PLUS technical training is the more desirable answer—and the employer wants these men.

YOUR FIRST STEP TOWARD SUCCESS in this New World of Electronics is your resolution to acquire a sound basic knowledge of the technical side of radio-electronics. Add this knowledge to your practical experience and place yourself ABOVE the competition of the "average" radioman. CIRE courses of supervised home study training are planned to do that job.

LET CIRE TAKE OVER YOUR PERSONAL UP-GRADING PROBLEM. Qualified, competent instructors, ample, personalized instructional aids, orderly, progressively arranged study assignments in recognized, approved technical texts—these are only a few of the many superior advantages of CIRE's plan of personalized spare-time home study training for professional self-improvement.

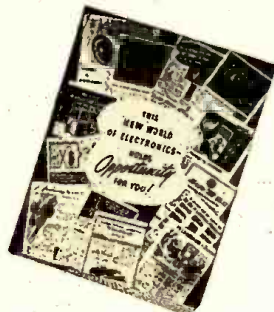

Write today for free, descriptive booklet. "THIS NEW WORLD OF ELECTRONICS HOLDS OPPORTUNITY FOR YOU." No obligation—no salesmen.

Aye, lad, CIRE is a grand school!



Choose the course best suited to your needs, and start with the section you are qualified to enter. You pay for only the section or sections you need. Use the "Pay-as-you-go plan" patterned after ethical, educational practice. These features are unique with Cleveland Institute, and represent the best in the modern, post-war concept of home study training.

Many CIRE students of advanced engineering courses today are broadcast chief engineers. Graduates of CIRE courses are eligible for the top jobs in radio-electronics.

## APPROVED FOR VETERAN TRAINING UNDER THE "G-I BILL OF RIGHTS"

# CLEVELAND INSTITUTE of RADIO ELECTRONICS

Contractors to the Canadian Broadcasting Corporation.

Successors to

NILSON RADIO SCHOOL, Founded 1939

SMITH PRACTICAL RADIO INSTITUTE, Founded 1934

RC-6 TERMINAL TOWER

CLEVELAND, 13, OHIO

MAIL THIS COUPON.

### CLEVELAND INSTITUTE of RADIO ELECTRONICS

RC-6 Terminal Tower, Cleveland 13, Ohio

Gentlemen: Please send information about your home study courses in Radio-Electronics.

NAME .....

ADDRESS .....

CITY .....

ZONE ..... STATE .....

I desire training in .....

I have had experience in broadcast-  
ing  servicing  operating   
mfg.  CAA  Army-Navy   
amateur  other .....

I am a High School Grad   
College Grad  War Veteran

I hold a ..... degree in .....



**NOMOGRAPH CONSTRUCTION**  
(Continued from page 631)

age will be  $1^2 \times$  or 1 watt, and the top figure  $10^2 \times 10$ , or 1,000 watts. Thus the center scale will have 31 cycles instead of 2 as in the straight multiplication charts.

But it will not be in the center. To locate this scale, we have to compute a few wattages, choosing them so the lines on which they lie cross at a broad angle. We can try 4 watts as a first attempt. This is  $1^2$  amperes  $\times$  4 ohms, or  $2^2$  amperes  $\times$  1 ohm. Draw both lines, as shown in the figure. Then find a similar point near the top of the scale, say, 360 watts. This is  $6^2$  amperes  $\times$  10 ohms, or  $10^2$  amperes  $\times$  3.6 ohms. Drawing these two lines to locate the 360-watt point, we find it directly above the 4-watt intersection. A vertical line can be drawn through the two points and calibrated in 3 cycles from 3-cycle paper or the diagonal guide.

Nomogram B, shown on page 628, is suitable for calculating safe dissipation for all bleeder resistors and line cords. Note that a safety factor of 100 percent is allowed. If 20 watts is required, use a 40-watt resistor. The scales are 100 to 10,000 ohms and 10 milliamperes to 1 ampere. The watts scale would normally have six cycles, but since we are not often interested in wattages greater than 1,000 and less than 0.1 watt, only four cycles are drawn. The watts scale is located as in Fig. 4, the 1-watt and 100-watt point being particularly convenient to locate. Easiest way to make this nomogram is to draw the outside lines 20 inches long and use a piece of 3-cycle paper to calibrate the watts scale.

Many other radio problems are capable of easy and continuous solution with nomograms. Part II of this article will describe constructions where reciprocals, square roots and additional constant factors are included in the problem, and will give nomograms for resistance of wires  $R = kl/C.M.$  and for inductance and capacity required to tune to a given frequency  $f = 1/6.28 \sqrt{LC}$ .

**URANIUM A PROTECTOR**

Deadly radiations from the uranium-made atomic bomb may be stopped short by shielding with glass containing the same mineral, Professor Alexander Silverman of the University of Pittsburgh revealed last month.

"Strange as it may seem," he said, "uranium, which is used indirectly in atomic bomb manufacture, produces a glass which is probably the best protection we have against powerful X-rays and other harmful radiations. In post-bombing rescue work, uranium or lead spun-glass garments and helmets lined with these glasses in plate form will permit safe entry into the bombed area. Oxygen respirators will be equipped with glass-insulated high-frequency precipitators to keep radioactive dust out of the lungs of the rescue squads."

**NEW and ALLIED'S 1946 CATALOG**

Ready for you!



of Radio and Electronic Supplies

**FREE**  
Send for it Now!

**LARGEST AND MOST COMPLETE STOCKS**

Today's handiest, most complete *Buying Guide!* Brings you latest, finest values in parts, tubes, kits, tools, books, test instruments, communications receivers, Ham gear, public address and other equipment. Places at your finger tips over 10,000 items of nationally known guaranteed quality. Makes available to you the world's largest and most complete stocks under one roof . . . ready for rush delivery. Enables you to get everything you need in radio and electronics from one dependable, central source. Send for this new 1946 Catalog now. Save time, work and money!



**NEW RADIO SETS**  
Parade of new 1946 models, including phonoradios, and latest communications receivers covering broadcast, short-wave and amateur bands. Beautiful styles! Wonderful performance! Outstanding values!



**HANDY RADIO BOOKS AND CALCULATORS**  
Radio Formulas & Data. Dictionary of Radio Terms. Radio Circuit Handbook. Radio Builders' Handbook. Simplified Radio Servicing. Radio Data Handbook — Six Books No. 37-799 . . . 75c.  
Parallel Resistance and Series Capacitance Calculator. No. K37-960 . . . 25c  
R-F Resonance and Coil Winding Calculator. No. 37-955 . . . 25c

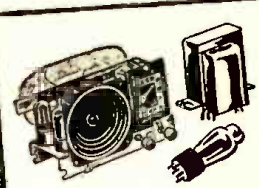

**OVER 10,000 ITEMS**  
Biggest section of quality parts and equipment for engineers, dealers, servicemen, soundmen, amateurs, builders. All leading makes, at lowest prices. Send for Free Catalog now.



**NEW P.A. EQUIPMENT**  
Sound systems for every public address requirement. Complete listing of amplifiers, speakers, microphones, accessories. Newest developments with many exclusive features.

**ALLIED RADIO CORP.**  
833 W. Jackson Blvd., Dept. 2-FF-6  
Chicago 7, Illinois

Date .....

Send FREE New 1946 Catalog.

Send Six Books—Calculator No. .... } \$..... enclosed  
Calculator No. .... }

Name .....

Address .....

City ..... Zone..... State.....

**ALLIED RADIO**  
Everything in Radio and Electronics





## MATHEMATICS, RADIO TOOL

(Continued from page 617)

Working from the bottom tap upward—

$$R_2 = \frac{E_3}{I_3} = \frac{50}{.005} = 10,000 \text{ ohms}$$

$$R_2 = \frac{E_2 - E_3}{I_3 + I_2} = \frac{100 - 50}{.005 + .010} = 3,333 \text{ ohms}$$

$$R_1 = \frac{E_1 - E_2}{I_3 + I_2 + I_1} = \frac{250 - 100}{.005 + .010 + .015} = 5,000 \text{ ohms}$$

No matter how many tapped resistors are used, we begin from the bottom and work upward as illustrated.

### CATHODE CONDENSERS

In designing an amplifier, the designer has to solve many factors. For instance, what value of cathode by-pass condenser is necessary for an amplifier with an approximately flat response down to 40 c.p.s. with a cathode resistor of 2,000 ohms? The reactance of the condenser is to be one-tenth of that of the cathode resistance (Fig. 4 below):

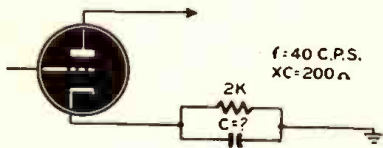

Using the formula:  $C = \frac{1}{6.28fX_c}$

Where C = value of condenser in farads, f = frequency in c.p.s., and  $X_c$  = reactance of condenser (in this example, its value will be 2,000/10, or 200 ohms):

$$C = \frac{1}{6.28fX_c} = \frac{1}{6.28 \times 40 \times 200} = 0.00001994 \text{ farads or approximately } 20 \text{ microfarads.}$$

### OUTPUT TRANSFORMER MATCHING

The primary winding of a particular output transformer has an impedance of 10,000 ohms. The technician wishes to place a speaker with a voice coil of 4 ohms across the secondary of this transformer. What ratio should exist between the number of turns on the secondary and primary windings, to provide proper matching? (Fig 5 below.)

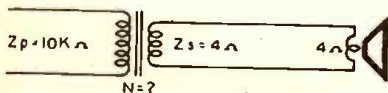

Using the formula  $N = \sqrt{\frac{Z_p}{Z_s}}$

Where N = number-of-turns ratio,  $Z_p$  = the impedance of the primary winding, and  $Z_s$  = the impedance of the secondary winding.

Then, substituting—  

$$N = \sqrt{\frac{Z_p}{Z_s}} = \sqrt{\frac{10,000}{4}} = 50:1$$

New! Spectacular! Complete!

# CONCORD RADIO CATALOG



RADIO SETS

AMPLIFIERS

RADIO PARTS

ELECTRONIC EQUIPMENT

Your Copy of the Complete, New Concord Catalog is Ready!

Mail Coupon for FREE Copy!

### WE HAVE WHAT YOU WANT!

The new Concord Catalog displays the most comprehensive stock in years! All well-known, standard lines are fully represented. Equipment—accessories—parts for all radio and electronic use . . . for building, repair, maintenance . . . for engineer, amateur, serviceman, soundman, retailer . . . complete lines of tubes, instruments, tools, speakers, condensers, resistors, relays, etc. . . PLUS a radio set department offering latest postwar models . . . PLUS the exciting line of MULTIAMP Add-A-Unit Amplifiers offering many innovations in public address units exclusive with Concord

It offers you the latest, greatest selection of guaranteed quality RADIO SETS, PHONO-RADIOS, RADIO PARTS, TEST INSTRUMENTS, BOOKS, TOOLS, AMPLIFIERS AND ACCESSORIES, AMATEUR KITS AND SUPPLIES, ELECTRONIC EQUIPMENT . . . page after page of post-war-engineered equipment and parts you have long been waiting for. All standard, top-quality lines. Thousands of items. Money-saving prices. And fast service, direct from our two centrally located warehouses in CHICAGO and ATLANTA.

See the first peacetime line of Concord Radio Sets in new, modern cabinets with a host of post-war features. See the thrilling MULTIAMP Add-A-Unit Amplifiers, brand new in the field, with sensational new flexibility, fidelity, and power—EXCLUSIVE with CONCORD.

See the vast stock of everything you need in equipment and parts . . . see them in the new, comprehensive Concord Catalog, just off the press. Your copy is ready . . . and it's FREE. Rush coupon today.

**CONCORD**  
 RADIO CORPORATION  
 LAFAYETTE RADIO CORPORATION

CHICAGO 7 901 W. Jackson Blvd. ATLANTA 3 265 Peachtree Street

CONCORD RADIO CORPORATION  
 901 W. Jackson Blvd.  
 Dept. RC-66 Chicago 7, Ill.

Yes, rush FREE COPY of the comprehensive new Concord Radio Catalog.

Name . . . . .  
 Address . . . . .  
 City . . . . . State . . . . .



**NEW  
IMPROVED  
MICROPHONE  
PLUGS & JACKS ELIMINATE  
NOISE - SHORTS - LEAKAGE**



**MODEL M-151**  
Female connector. Solid silver plated contact, coupling can be removed completely for soldering.

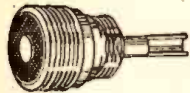

**MODEL M-161**  
Chassis mounting, solid silver plated contact. Milled flat, prevents turning in chassis.

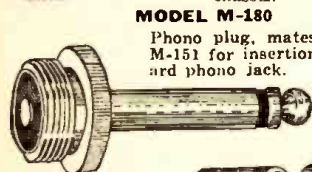

**MODEL M-180**  
Phono plug, mates M-150 or M-151 for insertion in standard phono jack.



**MODEL M-192**  
Solid silver plated contacts double female with coupling nuts.



**MODEL M-190**  
Solid silver-plated contacts double male, mates M-151 or M-160.

**STANDARD MICROPHONE  
JACKS AND PLUGS**



**MODEL M-170**  
Mates with Model M-151 and M-150 Standard solder contacts.



**MODEL M-160**  
Chassis mounting—standard solder contact.

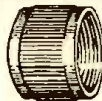

**MODEL M-191**  
Double female coupling mates M-170, M-160-161.



**MODEL M-150**  
Standard solder contact mates with models M-170, M-161, M-160.

**FOR FURTHER DETAILS  
CONTACT ROBBY**



**KINGS ELECTRONICS CO.**  
372 CLANSON AVE., BROOKLYN 5, NEW YORK

**BETTER BROADCAST TUNER**

(Continued from page 610)

serious distortion. Second, it may be advanced almost to the point of oscillation to provide high sensitivity and greater selectivity so that two adjacent powerful stations may be separated.

The detector is of the so-called infinite-impedance type, which has many advantages. It has very low distortion, which makes it particularly adaptable for high fidelity reception. Its low output impedance is not affected by shunt wiring capacities, so the high audio frequencies are not attenuated.

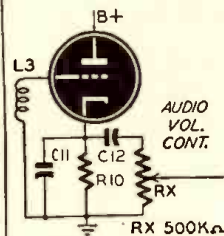

Fig. 2—How a volume control would be added to the circuit.

The output is taken from the cathode through a coupling condenser to keep the d.c. drop across the cathode resistor from biasing the first grid in the amplifier.

The wiring is straightforward, the heaters being wired first and then the grid and plate leads, care being taken to keep them short and well apart.

When the unit is finished it should be connected by means of the terminal strip shown in Photo D to 6.3 volts at 1½ amperes and 250 volts at 25 milliamperes. An amplifier should be connected to its output and turned on. The unit should have an outside antenna if it is to be used at some distance from a station. In the city you may use 20 feet of wire run under the rug, though an outside aerial will more than pay for itself by improving the signal noise ratio.

Turn the dial until a station is received. If no station is heard, then adjust the trimmers, listening to the noise level with the sensitivity control advanced full. When a station is heard, adjust the trimmers until it is at its maximum loudness. Start with the detector trimmer and work toward the one on the first r.f. stage. That done, turn the condenser all the way out to see if you can tune to a high enough frequency. If a sta-

tion is heard with the condenser all the way out, turn all the adjustable slugs in the coils clockwise several turns to reduce their inductance. Then readjust trimmer for maximum volume. Turn the condenser to the low frequency end (plates engaged) and readjust slightly. If the position of the trimmers is very different at this end of the condenser, bend the end condenser plates until the trimmer adjustment holds over the whole dial.

A dial of the slide-rule or airplane type would be desirable, but a plain knob and pointer may be used with a



Photo D—Terminal strip is seen in back view

Bristol board scale. The frequencies may be penned in with India ink.

The tuner when finished will prove to be well worth the work spent in its construction. The clean sound of the high frequencies and good bass will please even the most critical listener. Parts are not critical, though high-grade components will pay off in any high-fidelity tuner as in no other electronic device. A list of the required parts follows:

(Continued on page 660)

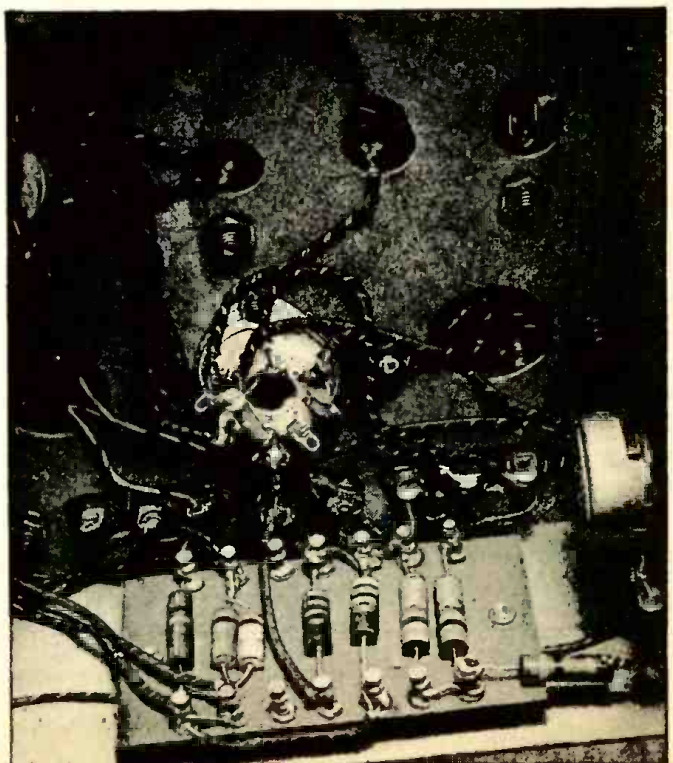

Photo C—How the resistor strip looks in a close-up. This method of attaching the resistors makes for better and more rigid wiring than letting them hang from tube prongs.

## FM CARRIER STABILIZATION (Continued from page 606)

the former reactance, current through the circuit leads the voltage by 90° and therefore the reactance tube circuit is an effective capacitance. Its value depends upon the plate current, which is dependent upon the grid voltage. In other words, the incoming audio voltage controls the size of capacitance which

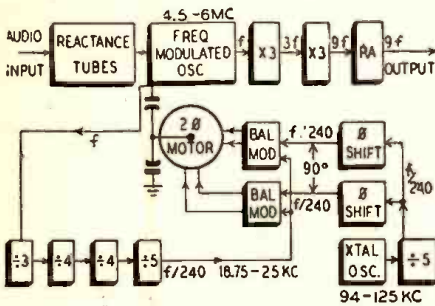

Fig. 9—Block diagram of the RCA stabilizer.

shunts the tuning tank and therefore the frequency of the oscillator.

The oscillator frequency is multiplied by 9 in two triplers. This places it in the FM band.

Convenience features the equipment. An oscilloscope is mounted on the control panel so that it can be used to observe the output of each divider to check the lock-in. The same control switch can also be used to connect the scope to either frequency multiplier (in the r.f. section) to adjust it to optimum.

Another selector switch is provided to check the motor action. A d.c. potential

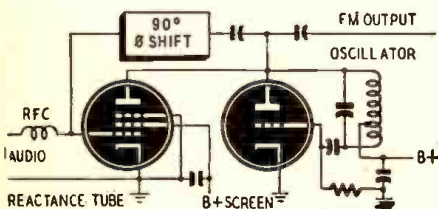

Fig. 10—Reactance-tube modulation. Control is accomplished by the plate tank condenser.

may be placed upon the modulator tubes, its value being sufficient to modulate the oscillator over a range greater than that ordinarily encountered due to ambient temperature or line voltage changes. A dial on the motor shaft may be observed to insure that the correction of frequency is as required. If for any reason the motor shaft rotates beyond the normal limits, a buzzer sounds to warn the operator.

Radios to the number of 100,000 will be produced in Austria, according to estimates by the government of that country.

This will do Austrian radio listeners little good, however, for the Government has decided that Austrians are too poor to afford such luxuries themselves, so almost all the 100,000 sets will be exported to get foreign exchange to buy food and essential raw materials.

# SOUND VALUES at TERMINAL RADIO

*The P. A. Systems You've  
been waiting for!*

- TOP-NOTCH QUALITY!
- HEAVY DUTY CONSTRUCTION!
- ECONOMICAL — COMPARE!
- HUM-FREE, NOISE-FREE!
- NEW IMPROVED DESIGN!
- AVAILABLE NOW — ORDER FROM THIS ADVERTISEMENT!



Model TR-1 14 watt heavy duty system COMPLETE

**\$57<sup>60</sup>**  
Net

**TERMINAL SOUND SYSTEMS** are famous for their long life and trouble-free performance. The new models here boast no superfluous fancy frills but are a new high in Sound Value — each amplifier incorporates a wealth of real, useable features for the power and tone quality heretofore unavailable in low-cost sound systems.

### 14 WATT HEAVY DUTY SOUND SYSTEM

A complete system—no extras to buy! Consists of 14 watt heavy duty amplifier, 10 inch permanent magnetic speaker in reinforced wall baffle (specify color—brown or grey), 25 ft. speaker cable, wide range crystal microphone with table stand and 15 ft. shielded microphone cable. Ready to plug in and operate!

MODEL TR-1 PA SYSTEM, as described and illustrated **\$57<sup>60</sup>** Net

MODEL TR-1D DUAL SPEAKER SYSTEM, (as above, but with two 10" speakers in wall baffles) **\$67<sup>95</sup>** Net

### 25 WATT HEAVY DUTY SOUND SYSTEM

Offers high fidelity sound reproduction with emphasis on quality and power! Consists of 25 watt amplifier, 12 inch permanent magnetic speaker in reinforced wall baffle (specify color—brown or grey), 25 ft. speaker cable, wide range crystal microphone with table stand and 15 ft. shielded microphone cable.

MODEL TR-2 PA SYSTEM, as described **\$71<sup>50</sup>** Net

MODEL TR-2D DUAL SPEAKER SYSTEM, (as above, but with two 12" speakers in wall baffles) **\$84<sup>95</sup>** Net

### 14 WATT AMPLIFIER SPECIFICATIONS

POWER OUTPUT: 14 watts normal  
GAIN: Microphone input 110 db.; phono input 70 db.  
FREQUENCY RESPONSE: 50 to 12,000 cps, hum —70 db. below rated output.  
INPUTS: 1-Microphone, 1-Phono (both high impedance). Separate gain controls for mixing and fading.  
TONE CONTROL: Full range bass and treble tone compensator.  
OUTPUT IMPEDANCES: 2, 4, 8, 16 and 500 ohms.  
TUBES: 1-7C7, 1-7F7, 2-7C5 and 1-5Y4G.  
POWER CONSUMPTION: 85 watts, 117 volts 50-60 cycles. A.C. Fused primary.  
SIZE: 13"x8½"x8½". Net wt. 15 lbs.

TR-1A AMPLIFIER ONLY, complete with tubes **\$33<sup>81</sup>** Net

### 25 WATT AMPLIFIER SPECIFICATIONS

POWER OUTPUT: 25 watts normal  
GAIN: Microphone input 112 db.; phono input 70 db.  
FREQUENCY RESPONSE: 40-13,000 cps, hum —65 db. below rated output.  
INPUTS: 1-Microphone, 1-Phono (both high impedance). Separate Gain Controls for mixing and fading.  
TONE CONTROL: Full range bass and treble tone compensator.  
OUTPUT IMPEDANCES: 4, 8, 12, 16 and 500 ohms  
TUBES: 1-6SJ7, 1-6SL7, 2-6L6 and 1-5U4G  
POWER CONSUMPTION: 120 watts, 117 volts 50-60 cycles. A.C. Fused primary.  
SIZE: 17"x9"x9". Net wt. 24 lbs.

TR-2A AMPLIFIER ONLY, complete with tubes. (Similar in appearance to TR-1A, but not illustrated here) **\$42<sup>63</sup>** Net



### WEATHERPROOF OUTDOOR SPEAKERS

MODEL PSAH—3½ ft. horn recommended for voice applications. High Efficiency, ½ mile sound projection, 25 watt driver unit. **\$37<sup>92</sup>** net

MODEL LSAH—4½ ft. horn ideal for music. Waterproof construction, ¾ mile sound projection, 25 watt driver unit. **\$47<sup>92</sup>** net

### MICROPHONE FLOOR STAND

MODEL MS-4. 10" diameter, heavy base, all chrome sections adjustable from 34" to 62". Positive locking clutch. **\$5<sup>25</sup>** net

Above prices are FOB New York. 25% deposit required with all COD orders.

# Terminal Radio Corporation

85 CORTLANDT ST., NEW YORK 7, N. Y. • Telephone: WOrth 2-4415

## TELEVISION FOR TODAY

(Continued from page 604)

transmitted during this resetting period, the trace would be completely out of place in the image. To eliminate this annoyance, the blanking pulse is employed.

The complete video signal, containing the camera signal and the blanking and synchronizing pulses is illustrated in Fig. 1. This is the form of the signal as it appears at the grid of the cathode-ray viewing tube. For each fluctuation of the camera voltage a different voltage is placed on the grid. This determines the number of electrons that pass into the scanning electron beam from the cathode. At the screen, the intensity of the light is a direct function of the number of electrons in the beam. When the line's end is reached, the grid is driven strongly negative, completely preventing any flow of current within the tube. Still under the influence of the blanking voltage, the receiver circuits are subjected to a synchronizing pulse, thereby setting up the beam for the following line. Once this is accomplished, the blanking voltage is removed and the camera signal once again assumes control.

At the end of a complete scanning run, when the beam has reached the bottom of the image, the vertical synchronizing pulse is inserted. See Fig. 2. This pulse lasts longer than the horizontal synchronizing pulse because the distance that the beam must travel—from bottom to top of the image—is much greater. It is also important that the horizontal synchronizing system is not permitted to slip out of control during this interval. Hence, the vertical pulse is broken up into a series of shorter pulses that permit control of the horizontal system at the same time. This explains why the vertical pulse is not actually one very long pulse, but rather a number of pulses closely connected, as evident in Fig. 2.

The FCC, in establishing the standards for television broadcasting, has designated the various proportions of the video signal. 75 percent of the total available amplitude of the signal is set aside for the camera variations. The remaining 25 percent is utilized for the blanking and synchronizing voltages. Since the point where the blanking voltage starts represents a point where no electrons reach the fluorescent screen, the name of *black level* has been assigned. Driving the grid more negative,

as the synchronizing pulses do, certainly does not cause fewer electrons to reach the screen, since all are cut off at the blanking level. However, to name this region, the term of *blacker-than-black* has been given. (See Fig. 1.) Actually, of course, no such state can exist.

To complete the television program, the transmission of sound must be included. While several schemes exist that permit the transmission of the sound and video signals on the same set of frequencies, the most common practice today is to send each separately. The sound band, however, is placed slightly beyond the upper end of the video band, close enough to permit both to

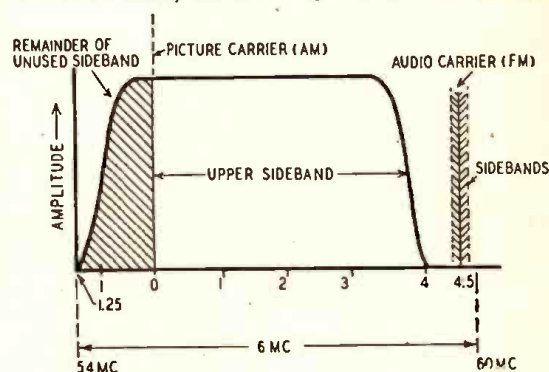

Fig. 3—Audio-video division of the television channel.

be received simultaneously at the receiver. The necessary 6 mc band is proportioned as shown in Fig. 3. It may seem curious that FM is used for the audio while the video is amplitude-modulated. However, field tests have indicated that this represents the best solution and the practice has been standardized by the FCC.

Now that we have seen the development of the video signal with its sound companion, let us investigate the arrangement of the circuits in a typical receiver, Fig. 4. A dipole antenna brings the signal down to the input stage.

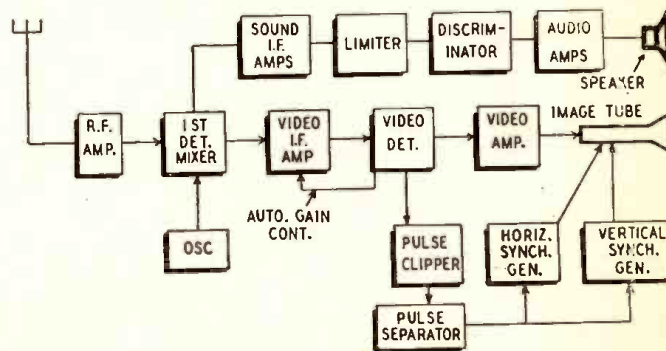

Fig. 4—Block-diagram representation of typical television receiver.

Whether the first stage is an r.f. amplifier or the mixer depends upon the price of the set as well as its location. In localities situated at the outer fringe of the broadcast stations' coverage area, an r.f. stage will probably mean the difference between enjoyable reception



● These Aerovox twist-prong-base electrolytics are again available to you. And they're still *extra-good* because: (1) They are tightly sealed. Note the unique rubber-sleeved terminals. (2) Rigid terminals, due to eyeletted construction. (3) Special provisions such as hi-purity aluminum foil throughout, minimize corrosion. Post-war listings provide outstanding selection of popular single and multiple section units in required capacities and voltages.

### Ask Our Jobber . . .

Ask for these extra-good Aerovox Type AF electrolytics. Ask for our post-war catalog. Or write us direct.



FOR RADIO-ELECTRONIC AND INDUSTRIAL APPLICATIONS

AEROVOX CORP., NEW BEDFORD, MASS., U.S.A.  
Export: 13 E. 40th St., New York 16, N.Y. • Cable: 'ARLAB'  
In Canada: AEROVOX CANADA LTD., Hamilton, Ont.

and poor or no reception at all. To be appreciated, a television broadcast must be clearly received. The eye is a critical judge and does not tolerate very much distortion. Random and background noise, to which all radio is subjected, combine with weak signals to produce an image covered with white specks. It is the function of the additional amplifier to increase the signal strength to the point where it will completely mask these noise voltages.

At the first detector, a separate oscillator produces a mixing voltage that reacts with the signal to develop the intermediate frequencies. Since the video and audio sections of the television signal have different frequencies, separate intermediate frequencies are produced. The separation occurs directly beyond the first detector, thus enabling us to deal with each signal according to its own characteristics. In addition, an early separation of both signals is necessary to eliminate any possibility of sound voltage reaching the viewing tube. Should this occur, a series of black bands appears on the screen, changing in intensity with the variations of the sounds.

Investigating the sound channel first, we find the usual lineup of stages necessary to transform an FM signal to its audio counterpart. The limiter removes all amplitude variations in the signal and thus serves as an excellent filter to guard against the trespassing of any video voltages into the loud speaker. Beyond the discriminator, the high-fidelity audio amplifiers produce enough power to drive a loud speaker. In most commercial receivers, standard broadcast reception is also included. To minimize the number of additional components needed to accomplish this, only an AM tuner is installed. A switch connects the output from this tuner directly into the audio amplifiers and the speaker. The same type of arrangement is possible on the regular FM bands. Thus, at very little extra cost, it is possible to have one cabinet house all three types of receivers.

Returning to the first detector, we find the video signal passing into a circuit much more complicated than the sound network. Aside from the additional pulse and generator stages, even the familiar i.f., detector and video amplifier stages contain many modifications. This is due to the video signal having a bandwidth which extends 4 mc. A distribution of this width is needed to convey all the image information, from the very large objects in a scene that can be reproduced by relatively low frequencies to the very small details, which require a much higher frequency. Uniform response for 4 mc in a tuned i.f. amplifier can only be achieved by adequate loading; and this, as we know reduces the gain. To counteract the loss in amplification, we find that one or two i.f. amplifiers are no longer adequate; now as many as four or five

(Continued on following page)

## HARRISON HAS IT!

### ALL STANDARD LINES

We are Factory Authorized Distributors for the top quality manufacturers and we now have in stock lots more new, latest improved production Ham gear! Visit our stores today, for everything you need. We promise you fresh, clean material—quicker—at the lowest current prices—and, above all, our sincere desire to be of friendly, helpful service.

MAIL ORDERS?—Certainly! Just list EVERYTHING you want and include deposit or full amount. (Please add postage if you want parcel post shipment.)

73 de  
BILL HARRISON, W2AVA

### TEMCO 75-GA TRANSMITTER

A post war transmitter of exceptional quality and dependability, incorporating many features of advanced design.—High stability VFO for crystal-like output in any part of every Amateur band covered.—Single dial tuning to simplify operation.—Band switching of factory tuned exciter stages.—crystal selector switch—voltage regulated oscillator power supply—etc. Conservatively rated output of 75 Watts phone and 100 Watts CW.

Engineered and constructed to highest standards of performance this TEMCO Transmitter is a sound investment for the discriminating Amateur.

Complete, with tubes, VFO, and coils for five band (10, 15, 20, 40, and 80) operation. **\$495**

Place your order now for delivery in May (Literature supplied upon request)

### NEW SOLDERING TOOLS

Kwickheat — Built-in thermostat—225 watt element—heats in 90 seconds. Net price, with tip. **\$8.91**

Weller Speed Gun—Trigger control gun type iron—5 second heating—wire loop tip. **\$12.95**

Met-Elec Soldering Gun—For operation on 6-volt battery or transformer. **\$2.94** With transformer for 115 V. AC. **\$6.43**

### ABBOTT TR-4A

New improved 144 Mc. transmitter-receiver in stock. Less accessories. **\$43.00**

### PANADAPTOR

Panoramic tuning adaptor. Easily attached to any standard communications receiver. Harrison has it! In stock. **\$99.75**

A POST CARD will put your name on our mailing list to receive new catalogs, bulletins, additional HSS bargains, and details of how you may obtain a copy of "Electronic Parts and Equipment," our new 800-page Buyers' Guide. Please send it today!

MILLEN ECO No. 90700. Compact, low drift, frequency shifter that plugs in, in place of crystal. Accurately calibrated. Built-in g o o d regulation power supply. Complete with tubes. **\$32.50**

### Corlab GROUND PLANE ANTENNA

Still the best made job for 2 meters! Solid, sturdy, adjustable, proven in service. Model GP-144. **\$8.82** S h u r Antennae, Beams, and Mounts IN STOCK.

Millen 50 Watt Transmitter-Exciter No. 90800. Output on four bands with one crystal or ECO. 6L6—807. Compact, versatile. **\$37.50** Less tubes.

### TELESCOPING ANTENNA

Signal Corps AN29-C. Sturdy, lightweight, brass antennae. Extends to 12' 10", closes to 15". 3/4" base diameter. Weighs only 30 oz. Good for mobile or rotary beam elements. **HSS \$1.98**

Subject to prior sale or price change without notice.

## HARRISON HAS IT!

### HSS—HARRISON SELECT SURPLUS

Your assurance of good, usable, guaranteed, surplus material at sensationally low prices—top value always! Come in and browse thru our large, entirely separate HSS Department (Harrison Select Surplus).

### SIGNAL CORPS RECEIVERS

Here's one of the hottest jobs to come out of the war—the BC-342! Two RF stages—two IF stages—exceptionally low noise level—high sensitivity—ten tubes—crystal filter—AVC—BFO—calibrated precision dial—4500 division vernier bandspread—beam power output to phones or speaker—9 1/2" x 18" panel—metal cabinet. Covers 1500 KC to 18 MC. (Use with 2, 5 and 10 meter converter for top efficiency on all bands.) Complete with tubes, speaker in metal cabinet and instruction manual—ready to operate on 115 volt 60 cycle AC.

A darn good, dependable, modern communications receiver at a sensationally low price. Slightly used, but checked by the factory and fully guaranteed. (AND WE HAVE THE GOOD ONES, WITH ALL THE BEST FEATURES!) **\$69.75**

For mobile, marine, etc. or emergency service—Model BC-312 operates on **\$49.25** 12-Volt Battery.

### Just a few left! HALLICRAFTERS BC-610

Complete with coils for 10, 20, 40 and 80 meters speech amplifier, tubes, factory converted for 10 and fully checked. (See our May ad in Radio-Craft Page 567) **\$535**

### REVERSIBLE MOTORS—FB for UHF Beams.

Totally enclosed motor and gear box. 3 RPM right angle drive shaft with ball thrust bearing. Runs on 24 to 30 volts AC or DC. Single wire reversing. Light weight aluminum construction. 3 1/2 lbs., 6 1/4" x 3 3/4" x 5" overall. Plenty power for 2 or 5 meter beam. Surplus Navy material—brand new! **\$14.90** Autotransformer for 115 Volt AC. **\$2.25**

### MORE!—15 TUBE UHF RECEIVERS

We have just secured more of those FB Signal Corps Model BC-406-A 205 Mc. receivers. These are all brand new, and sealed (also contain an 11 watt 65 RPM motor). Six acorn tube RF circuit, four IF stages, 115 volt 60 cycle operation, Chassis 10 1/2" x 25 1/2" in metal case. Complete with tubes: 6-954, 1-955, 4-8SK7, 2-8S37, 2-6N7, 1-5T4. Full instructions and diagrams for easy conversion to a hot 10 (also 6 and 2) meter superhet receiver are included. Parts alone are worth much more than our low HSS price. **\$29.75**

### FIELD STRENGTH METERS

Signal Corps I-149 Indispensable for tuning up beam antennae. Also can be used as foundation for 50,000 ohm per volt multimeter. Westinghouse NX-35 3 1/2" case 0-20 DC microammeter, tube, battery, low-high sensitivity switch; all in sturdy metal case 6" x 6" x 3" with carrying handle and plug-in pickup antenna. Operates on all frequencies. Complete ready to use. **\$13.90**

### HAND MIKES

Made for signal Corps by Shure, Model T-17, 200 ohm high sensitivity single button microphone, push-talk switch to close mike and relay circuit, five foot cable, plug, hang up hook on handle. Just the thing for mobile rig! Brand new. **\$2.75** HSS

### HSS CONDENSERS

Oil filled compact cylindrical type, mounts in 3/4" hole. Just the thing for transmitters, amplifiers, etc. Guaranteed at full rated DC working voltage. 2 Mfd.—1000 Volt—FOUR for \$2.34. (Regular price of one!) Standard rectangular type, with stand off insulator terminals. Oil filled, 4 Mfd.—1000 Volt—THREE for \$3.47, 8 Mfd.—1000 Volt—\$2.80. Flat type, lug terminals, oil filled, 2 Mfd.—600 Volt—FOUR for \$2.12.

### FILTER CHOKES

10 Henry, 250 Ma. General Electric, Metal cased, potting, ceramic stand-off insulators, 3 3/4" x 3 1/4" x 5" high, 8 1/2 lbs.—\$3.23

HAM HEADQUARTERS Since 1925!



HARRISON RADIO CORPORATION

12 WEST BROADWAY • NEW YORK CITY 7

BARCLAY 7-9854

JAMAICA BRANCH — 172-31 Hillside Ave. — REPUBLIC 9-4102

# LOOK!

## BEAM POWER TUBES



829-B push-pull R-F beam power amplifiers. Exceptionally efficient, with full input at frequencies up to 200 Mc. Max. ratings are: 750 plate volts, 40 watts plate dissipation. While they last...  
**\$4.95**  
 Stock Number WPS116

**R. W. T.**  
**BARGAINS of the MONTH**  
**LOOK!**

## ACORN TUBES

Government Released. Sensational offer. Normally \$2.85-45!  
 Stock No. WPS 422: Type 954.  
 Stock No. WPS 423: Type 955.  
 Stock No. WPS 424: Type 956.  
 Stock No. WPS 425: Type 957.  
 Socket for above.  
 W8464, price 49c



**69c**

**FREE!** Latest Bargain Flyer includes test instruments, record changers, communication receivers, ham transmitting tubes and many other electronic items you need today. Big new catalog coming! Get your name on our list!

**Radio Wire**  
**Television Inc.**  
 NEW YORK 13 BOSTON 10 NEWARK 2

Originators and Marketers of the Famous **Lafayette Radio**

Cut out coupon, paste on penny post card, mail today.

**R. W. T. Dept. RF6**  
 100 AVENUE OF THE AMERICAS, NEW YORK 13

Gentlemen: Send me FREE copy of your Latest Bargain Flyer and put my name on list for your Big New Catalog

NAME \_\_\_\_\_

ADDRESS \_\_\_\_\_

CITY \_\_\_\_\_ ZONE \_\_\_\_\_ STATE \_\_\_\_\_

## TELEVISION FOR TODAY

(Continued from previous page)

must be included. Again we encounter the same sort of situation in the video stages, the amplifiers between the detector and the image tube. Low- and high-frequency compensation are applied to an ordinary audio amplifier to extend the range of uniform response from 15,000 cycles to 4 mc. This, in itself, alters the appearance of the conventional amplifier.

At the video detector, a second separation of signal occurs. Part of the signal continues to the grid of the viewing tube, while part of the signal is applied to a pulse clipper stage. Here the horizontal and vertical synchronizing pulses are clipped off from the signal and directed to a pulse separator network. After separation, the pulses are used to control their respective

synchronizing generators. The generators form saw-tooth voltages (or currents) and by applying these voltages to deflection plates (or coils), the proper scanning action of the electron beam can be achieved. In practice, the generators operate as continuous oscillators, with the incoming synchronizing pulses triggering them off slightly before the start of their natural cycle. Thus the units are forced to keep in step with the received signal.

The video portion of the television signal is amplitude modulated and as such is subjected to all the disturbing influences of this form of modulation. For this reason automatic gain control is generally incorporated to prevent the intensity of the reproduced image from fluctuating too noticeably.

## HIGH-POWER U.H.F. TUBE

(Continued from page 608)

amplifier is the coupling system, shown in Fig. 1. This is a combination of straight resistance coupling and the old d.c. amplifier circuit. The video stages

coupling pack does not shunt the high frequencies.

At lower frequencies, where the coupling condenser would offer considerable reactance, both terminals of the coupling pack are raised or lowered in voltage by the same amount as the plate of the first stage, transferring the signal to the second stage through a path consisting of the isolating resistors and the pack itself. The region of transfer of signal from one path to the other is gradual and smooth, and the amplifier response is uniform from high video frequencies to d.c.

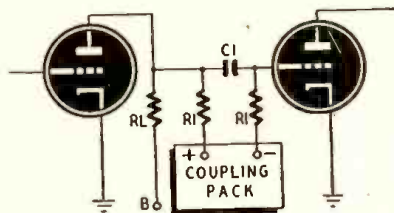

Fig. 1—The all-frequency coupling circuit.

are coupled together through an ordinary blocking condenser, the ends of which are connected through isolating resistors to the terminals of a regulated power supply, referred to as a coupling pack. This results in the higher-frequency video signals—which are most liable to attenuation by the by-passing effect of the pack's capacity to ground—being passed through the condenser. The isolating resistors (RI) are made very much larger than the first stage load resistor (RL) so the capacitance of the

Three video stages, using respectively a 6AG7, an 807, and two 807's in parallel, are followed by the first 6C22 (fourth video stage). With an input of 180 volts and a gain of 3.5, it puts out a signal of 700 volts.

The next stage—the final modulator—is a cathode follower using two 6C22's. The cathode-follower circuit is employed because it supplies a driving source of low impedance which, with the negative feedback characteristic of the circuit, tends to preserve a flat frequency response in spite of the shunt capacitance of the r.f. amplifier load.

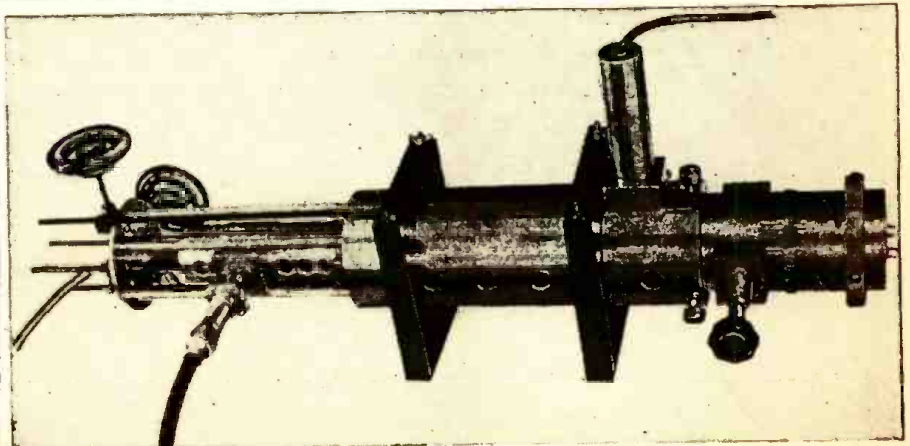

Photo B—A coaxial amplifier using the 6C22 tube, designed to operate at 490 megacycles.

## A PORTABLE INTERCOM

**A**N intercommunication unit, portable-style, is one of the first gadgets to burst upon the postwar market. It contains a five-inch PM speaker with a voice coil matched to a carbon-ball mike, a double-throw single-pole switch, and a pair of dry cells. All component parts are housed in a tent-shaped metal cabinet with two grills cut into the face; one for the mike and one for the speaker. The switch is a slide type and is mounted between the mike and speaker openings.

The hookup is basically simple as shown in Fig. 1. The carbon-ball mike was used for greater sensitivity as it is doubtful whether a carbon-granule microphone would be sufficiently sensitive to operate the PM speaker.

An additional advantage of this unit over other communicators is that it is portable to some extent. It can be used in the open field for a distance of about 120 feet with little loss of volume, and since it does not depend on an external source for power, it can be quickly set up from apartment to roof for example, when adjusting FM or television antennas. Location of such aerials with respect to the transmitting antenna and to possible sources of "ghost" responses is important. Many schemes have been tried to get best polarization, ranging from the use of a complete radio transmitter installation between receiver and roof to simply trying the set a few days, rotating the antenna a few degrees, and trying again. This intercommunicator offers another practical solution of the problem.

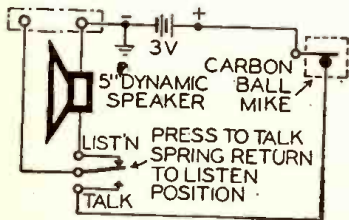

FIG. 1

When not in use, the batteries are not being drained. When one party presses the switch to the "talk" position, the batteries of the "talker's" unit operates the speaker of the "listener's" unit. The reverse occurs when the "listener" talks.



Nothing we can say about overwhelmingly popular "VOMAX" equals what its competent buyers say:

"Will increase your profits . . . measuring every type of receiver voltage. 'VOMAX' speeds work to give you more profit." That's mighty sound advice from such experienced distributors as R. G. Scelfi & Co., Hartford, Conn.; Welch Radio Supply of St. Petersburg, Florida; Radio Products Sales Co., Denver, Colorado.

"Only with 'VOMAX' can you measure every type of voltage in receiver servicing . . . no other instrument gives you this exclusive advantage." So say Arrowhead Radio & Television Supply Co., San Bernardino, Calif.; Northwest Radio, Duluth, Minn.; Continental Sales Co., Newark, N. J.

"All those vital measurements you've never been able to make before . . . you can now directly measure r.f., i.f., a.f., a.c. . . visual dynamic signal tracing on operating receivers." So state Universal Radio Supply Co., Louisville, Ky.; Radio Parts Co., Milwaukee, Wisc.; Ware Radio Supply Co., Brockton, Mass.; Evans Radio, Concord, N. H.

"Instantly acclaimed as the standard of comparison . . . carrying our highest recommendation." What more can you ask . . . when it comes from Stan-Burn Radio & Electronics Co., New York and Brooklyn, Carolina Radio Equipment Co., Raleigh N. C., Metropolitan Electronics and Instruments Co., New York, Harvey Radio Co., New York, N. Y.?

"Value far above \$59.85 cost . . . superb quality of parts, husky construction . . . give-away price." Carries conviction when Mattson's of Richmond, Va., say it.

These and over 500 more SILVER jobbers can supply your "VOMAX" promptly—the instrument the FACTORY recommends to all BENDIX RADIO distributors and dealers—the instrument the authorities use.

## "VOMAX"

Measures EVERY Voltage

1. Brand new post-war design . . . positively not a "warmed-over" pre-war model.
2. More than an "electronic" voltmeter, VOMAX is a true vacuum tube voltmeter in every voltage/resistance/db. function.
3. Complete visual signal tracing from 20 cycles through over 100 megacycles by withdrawable r.f. diode probe.
4. 3 through 1200 volts d.c. full scale in 6 ranges at 51, and in 6 added ranges to 3000 volts at 126 megohms input resistance. Plus-minus polarity reversing switch.
5. 3 through 1200 volts a.c. full scale in 6 ranges at honest effective circuit loading of 6.6 megohms and 8 mfd.
6. 0.2 through 2000 megohms in six easily read ranges.
7. - 10 through + 50 db. (0 db. = 1 mw. in 600 ohms) in 3 ranges.
8. 1.2 ma through 12 amperes full scale. 6 d.c. ranges.
9. Absolutely stable—one zero adjustment sets all ranges. No probe shorting to set a meaningless zero which shifts as soon as probes are separated. Grid current errors completely eliminated.
10. Honest, factual accuracy:  $\pm 3\%$  on d.c.;  $\pm 5\%$  on a.c.; 20 $\mu$ s through 100 megacycles;  $\pm 2\%$  of full scale,  $\pm 1\%$  of indicated resistance value.
11. Only five color-differentiated scales on 4 $\frac{1}{2}$ " D'Arsonval meter for 51 ranges (including d.c. volts polarity reversal) eliminate confusion.
12. Meter 100% protected against overload burnout on volts/ohms/db.
13. Substantial leather carrying handle. Size only 12 $\frac{1}{2}$ " x 7 $\frac{3}{4}$ " x 5 $\frac{1}{2}$ "

Send postcard for free catalog of measurement and communication equipment.

OVER 35 YEARS OF RADIO ENGINEERING ACHIEVEMENT

*W. W. Murdoch Silver Company*  
1200 MAIN STREET, HARTFORD 2, CONNECTICUT

## CORRECTION

The article "Dummies Save Tubes," which appeared in the March issue, page 437, contained an error in the placement of the drawings. The positions of the two drawings at the bottom of the page became reversed in the printing processes. The drawing on the left, having two 28-ohm resistors connected in series between pins 2 and 7, should have been placed over the caption: "(c) dummy for 3Q5" and the drawing with the 14-ohm resistor connected between pins 2 and 7 should have been placed on the left of the column over the caption "(b) -0.1-ampere dummy."

Our thanks to Mr. Marcus H. Moses of New York City for calling this error to our attention.

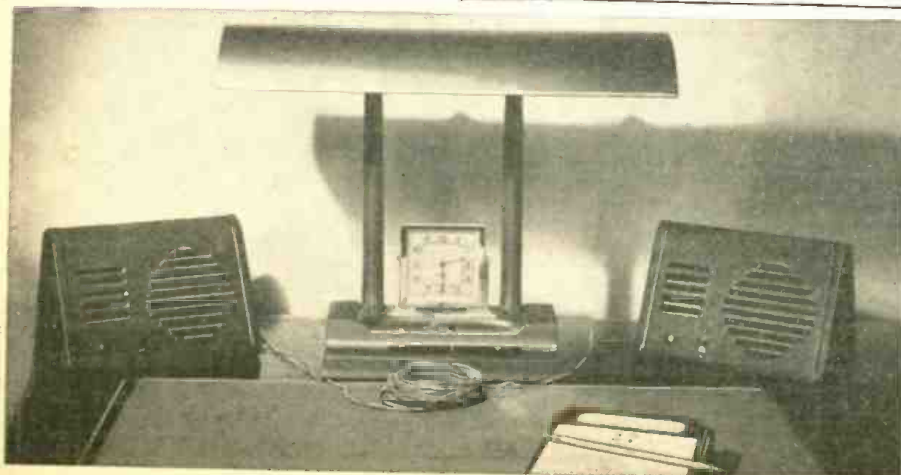

## 20 Watt 6V or 110V Hi-Fidelity Amplifier



- Tubes: 2-6J7, 1-6SC7, 2-6L6G, 2-6X5.
- Two Microphone inputs
- Separate control for tone, Phono, and each Microphone
- No switching necessary for battery or electric operation
- For two speakers

YOUR cost...\$81.00

### ACCESSORIES:

- 2—PM12C Jensen 12-in. PM speakers \$12.50 ea.
- 1—33X Turner Crystal Microphone... 14.70
- 1—MS-12C adjustable floor stand... 5.58
- 2—Leatherette 12" wall cases..... 5.10 ea.

West Virginia's  
Largest Radio  
Supply House

Write for  
Latest  
Catalog

All Standard  
Lines Carried  
in Stock

WE SELL: "DEALERS ONLY"

# SIGMON'S

CHARLESTON, WEST VIRGINIA

## MORE SMASH BUYS at National Radio Distributors



### IMMEDIATE DELIVERY NEW POST-WAR SCOOP

5 tube AC/DC Superheterodyne Radio Kit featuring built-in loop antenna, using 12SA7, 12SK7, 12SQ7, 50L6, 35Z5 tubes. All parts brand new and perfectly matched. Absolute satisfaction guaranteed. Complete including cabinet and full instructions for assembling. \$12.95  
 Kit of 5 matched tubes..... \$ 4.95  
**SPECIAL-NEW MAGUIRE ARC-1 RECORD CHANGERS**, precision engineered, single control knob, plays 10" 12" or 12 1/2" records, stops automatically after last record is played. Extra lightweight pick-up arm, features spring mounting and heavy duty rugged motor..... \$22.95  
**PAC 100 PORTABLE RECORD CHANGER CASE**, dark brown leatherette covered. Will accommodate above or any other make changer. Mounting panel 15 3/4" square.  
**NET.....\$8.95**



**NEW POST-WAR PORTABLE RECORD PLAYER KITS**  
 Model RC300 Complete portable player including beautiful alligator or leatherette covered portable carrying case, motor, 3-tube amplifier using 12SQ7, 50L6, 35Z5, Crystal pickup arm, 6" PM speaker with output transformer. Will play 12" records with lid closed and volume controls.  
 Your cost, \$25.95 less tubes  
 Kit of 3 matched tubes.....\$2.95

Model RC300 Same as above with NEW Maguire Record Changer and 2-toned leatherette portable carrying case to match. Will take 10"-12" or 12 1/2" records with lid closed.  
 Your cost.....\$44.95 less tubes

### COMPLETE INSTRUCTIONS FOR ASSEMBLING

**EXTRA SPECIAL!—BY-PASS CONDENSER KIT.** Consists of 100 Tubulars (all 600 Volt) in the following sizes: .001, .002, .005, .01, .02, .03, .05 and 1 Mfd. All fresh stock; fully guaranteed. Per Kit \$5.95

Please include at least 25¢ with C.O.D. orders.  
 Write for New Free Catalog Now!

## National Radio Distributors

1029 E. 163 St., New York 59, N.Y.

## THREE-CHANNEL AMPLIFIER

(Continued from page 607)

On the other hand, we will devote more time and details to the interesting and unusual features of the amplifier.

The 1-megohm resistors R1 and R2 isolate the three inputs from each other, preventing a mutual short-circuit. The condenser C1 has as its object the short-circuiting of the high and medium notes for its particular input. Therefore the 6F5 stage at the top of the schematic is the "bass" pre-amplifier. Its gain is regulated by the volume control P1. The condenser C2 prevents basses from reaching the grid of the 6F5 directly below the "bass" input. Therefore, only mediums and highs pass.

ferent impedances. This arrangement—two 6F5's, 6C5 and two 6A5's—constitute the "bass and medium" amplifier.

The low capacity condenser C3 (25  $\mu$ f) permits only the highs to pass. To enhance this effect the cathode circuit of the 6J7 is decoupled with a condenser of only 0.1  $\mu$ f (across 800 ohms) which reduces the bass and medium notes through degeneration.

This stage constitutes the "high" pre-amplifier. Its gain is also independently controllable, by volume control P3. It is followed by a 6F5 and 6F6.

The output transformer feeds a little speaker, of a small diameter intended

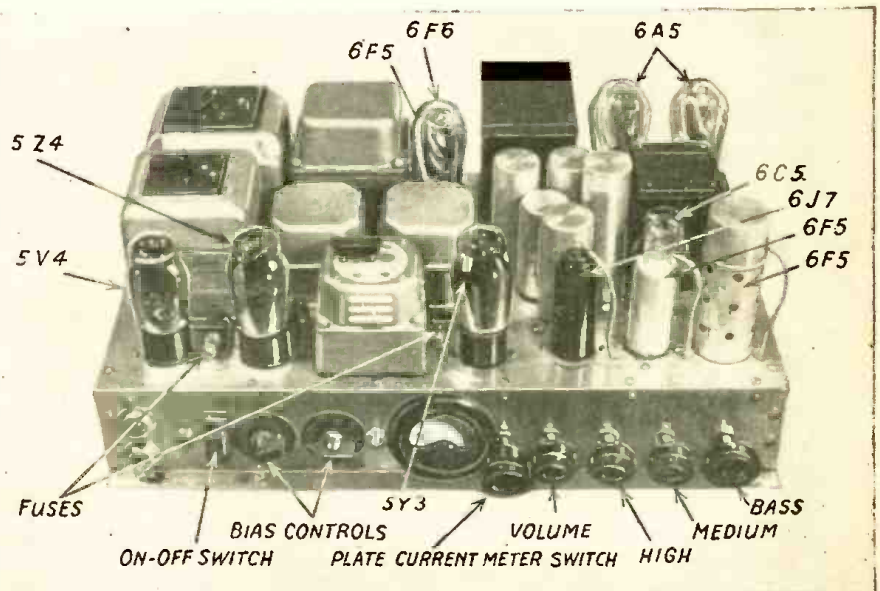

But, as we shall see, the highs will be attenuated further on. This stage constitutes therefore the "medium" pre-amplifier, controlled by P2.

The output of these two stages is applied, through a common volume control P4, a 6C5 and a transformer, to a push-pull stage, using 6A5 triodes. Their low internal resistance permits excellent reproduction of the basses. The negative feedback circuit R4, C4 weakens the high notes, the condensers C4 being of low value (50 $\mu$ f). The output transformer has two windings, the higher potential one being tapped to permit adaption to loud speakers of dif-

only for the reproduction of the highs. Under such conditions, this speaker has a marked directional effect. To soften this effect, signals of lower frequencies may be fed (at low level) into the "high" amplifier. This has been done through use of the resistor R.

Let us note also the milliammeter which permits rapid comparison of the plate currents of the 6A5's, or measurement of the total plate current of the two; a feature which facilitates balancing the push-pull stages and also gives a check on the condition of the amplifier.

Reprinted by special arrangement from *Toute la Radio*, Paris, France.

## RADIO-ELECTRONIC QUIZ

How thoroughly have you mastered the contents of this magazine?

Try the following quiz as a test:

1. How does a radio wave react when focussed by a metal lens? See page 602.
2. What is a television blanking pulse? See page 604.
3. What is a nogram and how is it used? See page 609.
4. Can quartz crystals be used as superheterodyne oscillators? See page 611.
5. What is the band-width of a video amplifier? See page 613.
6. How do radio-frequency power supplies work? See page 616.
7. How would you design a voltage divider? See page 617.
8. What is the width of a television channel? See page 638.
9. What is a two-dimensional radio? See page 643.
10. What is the difference between a sniper-scope and a snooperscope? See page 651.



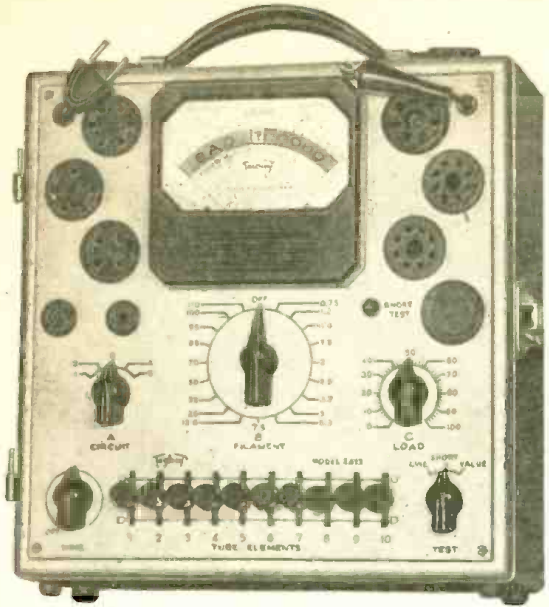

## The New Speed-Chek Tube Tester

**MORE FLEXIBLE • FAR FASTER • MORE ACCURATE**

Three-position lever switching makes this sensational new model one of the most flexible and speediest of all tube testers. Its multi-purpose test circuit provides for standardized VALUE test; SHORT AND OPEN element test and TRANSCONDUCTANCE comparison test. Large 4" square RED • DOT life-time guaranteed meter.

Simplicity of operation provides for the fastest settings ever developed for practical tube testing. Gives individual control of each tube element.

New SQUARE LINE series metal case 10" x 10" x 5 1/2", striking two-tone hammered baked-on enamel finish. Detachable cover. Tube chart 8" x 9" with the simple settings marked in large easy to read type. Attractively priced. Write for details.

### Model 2413

is another member of  
the **NEW TRIPLETT**  
Square Line

#### Additional Features

- Authoritative tests for tube value; shorts, open elements, and transconductance (mutual conductance) comparison for matching tubes.
- Flexible lever-switching gives individual control for each tube element; provides for roaming elements, dual cathode structures, multi-purpose tubes, etc.
- Line voltage adjustment control.
- Filament Voltages, 0.75 to 110 volts, through 19 steps.
- Sockets: One only each kind required socket plus one spare.
- Distinctive appearance makes impressive counter tester.

*Precision first  
...to last*



# Triplet

ELECTRICAL INSTRUMENT CO. BLUFFTON, OHIO



## TWO-DIMENSIONAL RADIOS

RECENT war-time developments in electronic circuit technique make it possible to virtually "print" a highly efficient circuit, complete with wiring, resistors and condensers, upon a ceramic plate. Batteries and tubes are soldered to the printed circuit to complete the assembly. The new development was announced in the April issue of this magazine.

The new process, developed by Centralab engineers, uses the silk screen method to apply "silver ink" to the ceramic surface. The "ink" hardens to produce a silver conductive circuit instead of the usual copper wire.

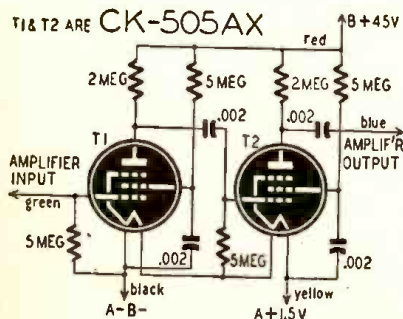

Fig. 1—Circuit of amplifiers in the photos.

Figure 1 above shows the diagram of a conventional two-stage amplifier circuit, using "hearing aid" tubes. This amplifier was used in the famous prox-

imity fuze. In developing a technique for rugged miniature wiring circuits, for this application, the engineers came up with the "two-dimensional wiring" technique. This development makes possible unbelievable reductions in the physical size of a radio circuit. To illustrate the drastic reduction in size, Photos A and B, contrast the conventional assembly of Fig. 1 and the same circuit with the newly developed technique.

The smaller circuit is conspicuous by the apparent absence of condensers and resistors. The resistors are the small black lines which appear at the left of the tubes. They are made by screening a heavy paint, containing a large proportion of finely divided carbon onto the surface. The resistance is regulated by the length, width and chemical composition of the printed lines. Using this method, resistors ranging from 3 ohms to 200 megohms have been produced. A resinous coating is applied to the resistor to protect it from the effects of moisture, thus making it stable under all conditions.

The condensers are made from thin ceramic discs plated on each side with silver (Photo B). The capacity varies directly as the area of the plating and the thickness of the discs. It is possible to produce condensers by this method that vary in capacity from 6.5  $\mu\text{f}$  to .002  $\mu\text{f}$ .

Special solder must be used for connecting power leads and tubes into cir-

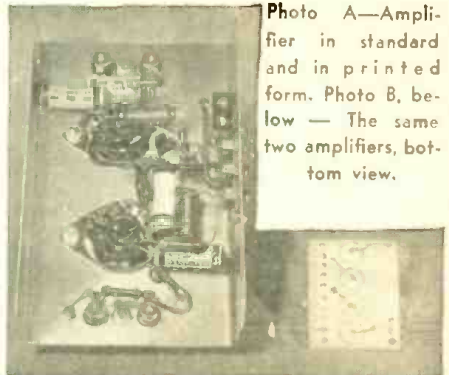

Photo A—Amplifier in standard and in printed form. Photo B, below — The same two amplifiers, bottom view.

cuit. A solder having at least 2 percent silver content must be used to prevent the absorption of silver ink from the surface of the plate. A low-temperature bismuth solder is used to fasten the tiny silvered capacitors to the silver leads because the heat used with normal solders would fracture the ceramic discs.

(Continued on page 647)



*Immediate Delivery*

## ON RADIO AND ELECTRIC SUPPLIES

As old as Radio itself—as up-to-date as electronics — is Radio Electric Service Co. of Pa. Rely on an established house for parts and equipment from the biggest standard lines in the country.

### NEW SERVICE FOR "HAMS"

Our main office features new show and display rooms plus SOUNDPROOF STUDIOS for your convenience.

### BARGAIN BASEMENT SPECIALS

Visit our new main store "bargain basement" for special values.

### FREE ILLUSTRATED FLYER

Scores of exciting values listed. Country's largest, most complete stock. Saves time, money and work. Ready for rush delivery.

### MAIL ORDERS FILLED PROMPTLY

## RADIO ELECTRIC SERVICE CO.

OF PENNSYLVANIA

N. W. Cor. 7th and ARCH Streets, PHILADELPHIA 6, PA.

### BRANCHES

3145 N. BROAD ST., PHILADELPHIA, PA.  
5133 MARKET ST., PHILADELPHIA, PA.  
811 FEDERAL ST., CAMDEN, N. J.  
S. E. Cor. 4th & TATNALL, WILMINGTON, DEL.  
1042 HAMILTON ST., ALLENTOWN, PA.  
9 NORTH SECOND ST., EASTON, PA.

RADIO ELECTRIC SERVICE CO.  
N.W. Cor. 7th & Arch Sts., Philadelphia 6, Pa.  
Gentlemen: Send me FREE copy of your latest Flyer.

NAME .....

ADDRESS .....

CITY .....ZONE.....STATE.....

## TECHNOTES

### .... LOW RESISTANCE LEADS

Save the flat copper "dial cords" from those old Atwater Kent receivers that you junk. Sections from them will make very nice low-resistance, flexible leads for plates and grids, especially for HY615's and HY75's used extensively in WERS transmitters now being converted to 144 mc ham rigs.

B. BUEHRLE, JR.,  
Ferguson, Mo.

### .... EMERSON FU424 AND FU427

A common complaint of these sets is low plate voltage and loss of filament voltage. The filaments of the 1.4-volt tubes are heated by the cathode current of the 117P7 (pentode section) passing through them.

An open input filter condenser will be found to be responsible for the troubles and will have to be replaced.

STANLEY RUTKOWSKI,  
Erie, Penna.

### .... WESTINGHOUSE M 108, M 112

When these models are subjected to humid air for a length of time, it will be noticed that the tone quality becomes very bad. This condition is caused by the voice coil coming loose from the speaker cone and may be cured by applying speaker cement freely where the voice coil and cone join.

A. K. MEMON,  
Karachi, India

(Note that such troubles are more likely to occur in hot humid climates such as the writer's.—Editor)

### .... ATWATER KENT 46

A "dead" set may be the result of the voice coil leads on the speaker cone breaking loose from the flexible leads from the output transformer. Checking and resoldering can be done without removing the cone.

B. BUEHRLE,  
Ferguson, Mo.

### .... SPEAKER REPAIRS

In speaker repairs where it is necessary to remove the paper cone, lacquer thinner, which may be purchased from most paint stores for about fifty cents a quart, may be used. Place the speaker face down in a tin pie plate and fill with thinner to a level that just covers the speaker rim. After soaking about twenty minutes the cone is easily removed.

Many plastic parts that have warped may be straightened by dipping in hot water and bending back to their original shape while flexible. They will retain their shape when cool.

HUBERT WATKINS,  
Gulfport, Miss.

### .... PHONO PICKUP HINT

I have often had trouble putting a new needle in a phono pickup head. This is especially true of heads that cannot be raised high enough to view the needle hole. Try laying a small pocket mirror under the head and the job becomes an easy one.

HOWARD SCHLIEF,  
Fairfield, Pa.

## Civilian Radio Jobs Wanted

### FREE WANT-AD SERVICE

By Former Soldiers, Sailors, Marines

Radio-Craft offers its help-wanted columns free for the use of honorably discharged men in the armed services. State the type of position you seek, preferred locality, your experience, education, and other details. Confine ad to 50 words, or less. Supply name and address. Army veterans send section number or photostat of discharge paper. Navy men send photostat of discharge paper. Address RADIO-CRAFT, Classified Ad, Dept. 25, West Broadway, New York 7, N. Y. Your ad will contain a box number and replies will be forwarded to you.

### AVAILABLE

BROADCAST STATION looking for experienced technician or chief, contact Louis Tulchin, 473 Empire Blvd., Brooklyn, N. Y.  
ELECTRONICS: married; trained; desires chance as jr. engr., technician. R. Kahn, 2935 Ocean Parkway, Brooklyn 24; DE 6-2520.  
ELECTRONIC TECHNICIAN: 2½ yrs. Navy; desires pos. lab. tech. or electronic maintenance repair. F. Kapko, 273 Hawthorne Ave., Yonkers, N. Y.  
ELECTRONICS TECH.:—2½ yrs. civilian experience; 2 yrs. Navy Radio-Radar, Electronics. Married. Roy Segal, 319 W. 94th St., New York 25.  
RADAR MAINTENANCE Repairman, also radio technician, skilled army civilian exp. S. Emmer, 1285 Brook Ave., Bronx 56.  
RADAR-RADIO MECH.: 3 yrs. Army exp., practical instructor; married; 2 yrs. coll. M. Stark, 3118 Brighton 4th St., Brooklyn 24.  
RADAR TECH.: 3½ yrs. exp., excellent electronic training, latest airborne equip., Lorain. I. Gerstein, 612 Argyll Rd., Brooklyn 30.  
RADIO: 3 yrs. navy; radio, radar; dv. exp.; repair and technical ability. I. R. Mendel, 1218 Hoe Ave., Bronx 59.  
RADIO Repair and Salesman: 21; prefer over counter sales; 40 hr. \$40. M. Baker, 1302 Ave. K, Brooklyn 30.  
RADIO MECH.: 3 yrs. Army exp.; willing to start as trainee or helper. L. Brown, 323 Alabama Ave., Brooklyn 7.  
RADIO MECH.: 16 mos. instructor. GCA blind landing unit, bus. exp. J. J. Ehrlich, 521 E. 135th Street, New York.  
RADIO OPER.: Young 2½ telegr. lic.; on the job radio-training acceptable. Y. Shieber, 3204 Holland Ave., Bronx 67, N. Y.  
RADIO PARTS AND SUPPLIES inside salesman, some experience; job with future. Walter Cohn, 1265 Gorard Ave., New York 52.  
RADIO-RADAR TECH.:—3 years Navy; Desire position in television. ITHP, R.M. A. Levine, 438 Christopher Avenue, Brooklyn 12, N. Y.  
RADIO AND RADAR Mechanic: Graduate of two U.S. Army radio schools. 20 months radio and electrical service overseas. Desire position with an Airline Co. as a radio and radar shop mechanic. Joseph O. Ferguson, Parrish, North Dakota.  
RADIO-RADAR TECHNICIAN 2 years Army, 3 years civilian exp. Attended ICA Institute as well as army radio and radar schools; Familiar all test equipment, can drive. Seeks position in laboratory or servicing. O. Berenberg, 953 Anderson Avenue, Bronx 52, N. Y. JE 7-1626.  
RADIO-RADAR mechanic: 3 yrs. Army exp. as mechanic-instructor. A. C. Rachman, 8807 Ave. A, Brooklyn 3, DI 2-8907.  
RADIO REPAIR TRAINEE: 2 yrs. AAF Radio & Radar; Radar instructor 1 yr. H. Rice, 156 Vard St., Bklyn 6.  
RADIO REPAIRMAN—Wired: civ., Army exp.; desires perm. job; chauff. license. H. P. Rublen, 120 W. 175th St., N. Y. 53.  
RADIO REPAIR exp.: service school; desire to learn more in allied field. chauffeur's license. H. Oken, Box No. 12, ½ Radio-Craft, 25 West Broadway, New York 7, N. Y.  
RADIO TECH.: 4 yrs. radio maint., exp'd repairs, troubleshoot, sales service. B. Lieberman, 1643 E. 3rd St., Brooklyn 30; ES 5-1589.  
RADIO TECH.: married; exp. radio sales and service, electrical appliances, repairs. J. Schoenes, 94 Blake Ave., Brooklyn 12; DI 6-1325.  
RADIO TECH.: exp. radio, teletype equip., radar training; desires pos. N. Vartabedian, 31-42 35th St., Long Island City 3; AS 8-6079.  
RADIO TECH.: Comm. radiotelephone 1/c F.C.C. lic., any opp. in radio. B. Dane, 2115 Walton Ave., Bronx 53.  
RADIO TECHNICIAN: 1st class Phone Lic., desires work in broadcasting field, studio or transmitter. A. Steinberg, 592 East 54 St., Brooklyn 3.  
RADIO TECHNICIAN: 3 yrs. exp. Army Radio Station; 3 yrs. college B.S. S. Bernard, 571 E. 170 St., Bronx 56, N. Y.  
RADIO-TELETYPE Single Channel repairman, receivers, equipment, 8 yrs. Signal Corps, Frederic Cass, Jr., 232 Hamilton St., Geneva, N. Y.  
RADIOTELEPHONE OPERATOR—Holds first class FCC license. Graduate Newark Radio Inst., Army exp. as Chief Electrician, Marine Maintenance and Repair. Desires suitable position with future. Joseph Damroth, 1494 University Ave., Bronx 52, N. Y.  
RADIOTELEPHONE Tech. 1/c. F.C.C. lic., broadcasting and teaching exp., anything radio. Free to travel. L. Tulchin, Box No. J-1, ½ Radio-Craft, 25 W. Broadway, New York 7, N. Y.  
TECHNICIAN, Radio and electrical appliances. 6 yrs. Army exp., installing and maintaining high and low frequency equipment for Alaska Communication System. Licensed amateur code speed 25. Can type and drive car or truck. Seeks employment with manufacturing concern offering possibilities for future. 33 yrs., married, 2 dependents. M. J. Martin, 12 No. 19 St., East Orange, N. J.  
RADIO TECH.: B.S.; 1/c radio tel.; lic. Army instr.; rec. and trans. H. Mertz, 1801 Bryant Ave., Bronx 60.

# H. F. Wideband Amplifier

**POSTWAR** video amplifier design is demonstrated in the illustrated compact high-frequency amplifier, manufactured by Sylvania Electric Products, Inc. Supplied for center frequencies between 30 and 70 mc. with any bandwidth from 2 to 10 mc., these sets are designed particularly for use as i.f. amplifiers in u.h.f. and s.h.f. receiver applications.

These units are well worth study by the serviceman and technician, for, with modifications for various applications, they are typical of what will appear in many kinds of high-frequency broadcast, television and communications apparatus.



This is the amplifier whose circuit is shown in the diagram below. It does not differ greatly in appearance from ordinary equipment.

A typical amplifier has an overall gain of 100 db with a center frequency of 60 mc and a half-power bandwidth of 9.0 mc. An external gain control is easily provided. Unless otherwise specified, a standard 500 ohm input impedance is supplied. The output stages are cathode followers designed to operate into impedances of 75 to 100 ohms with voltages ranging from 0.5 to 2.0 volts, negative or positive.

Video amplifier technique appears in the low plate resistors, high-frequency grid chokes, special chokes in the filament circuits and other features readily noticeable on the schematic. Gain per stage is low—thus eleven tubes are required for the 100-decibel gain.

The video detector may take one of several forms according to the special application of the amplifier. In broad-band circuits the frequency characteristics of the rectified video components will be such that the output at 8 mc will be reduced not more than 3 db from the output at 1 mc. These amplifiers will thus pass a square top pulse having a duration of 0.15 micro-second or greater with negligible frequency or phase distortion, making them particularly suited to television receiver applications.

Either single-ended or balanced input circuits are supplied. The balanced input circuits are designed to use with dual input systems and will distinguish between in-phase and out-of-phase signals from two channels. In one such unit this discrimination is 33 db.

The unit, as may be seen from the photograph, differs little in appearance from more conventional apparatus, the only external signs that distinguish it from an ordinary amplifier being the special small chokes.

Power supply for a typical amplifier includes + 105 volts d.c. at 90 ma, + 300 volts d.c. at 20 ma, and 6.3 volts a.c. or d.c. at 1.7 amperes. External gain control requires 0 to -12.5 volts d.c. 1.5 ma.

## OPPORTUNITY AD-LETS

Advertisements in this section cost 20 cents a word for each insertion. Name, address and initials must be included at the above rate. Cash should accompany all classified advertisements unless placed by an accredited advertising agency. No advertisement for less than ten words accepted. Ten percent discount six issues, twenty percent for twelve issues. Objectionable or misleading advertisements not accepted. Advertisements for July, 1946, issue must reach us not later than May 23, 1946.  
Radio-Craft • 25 W. B'way • New York 7, N. Y.

**MAGAZINES (BACK DATED)**—FOREIGN, DOMESTIC, arts, Books, booklets, subscriptions, pin-ups, etc. Catalog 10c (refunded). Cicerono's, 863 First Ave., New York 17, N. Y.

**AMATEUR RADIO LICENSES, COMPLETE CODE and theory preparation for passing amateur radio examinations. Home study and resident courses. American Radio Institute, 101 West 63rd Street, New York City. See our ad on page 660.**

**CORRESPONDENCE COURSES AND SELF-INSTRUCTION books, slightly used. Sold, Rented, Exchanged. All subjects. Satisfaction guaranteed. Cash paid for used courses. Complete information and 92-page illustrated bargain catalog Free. Write—NELSON COMPANY, Dept. 2-39, Chicago 4.**

**SURPLUS RADIO AND ELECTRONIC PARTS AND equipment. New and used. Write for free list. Highbridge, 312 Canal St., New York City 13.**

**"REFRIGERATION SERVICE MANUAL"—DOMESTIC, commercial. Construction, operation, installation, testing, trouble shooting, replacement, repair, etc. 300 pages; fully illustrated, \$2.25 postpaid. Money back guarantee. All books on techniques, radio, television, homecrafts. Free catalogue. Modern Technical Book Co., Dept. MRC, 55 West 42nd St., New York 18.**

**YOUR NEW FREE CATALOG IS READY! RADIONIC'S Catalog lists hard-to-get radio parts and books. All available for immediate shipment. Send today to: Radionic Equipment Co., Dept. N6, 170 Nassau St., New York 7, N. Y.**

**PLANS 1-TUBE DC RECEIVER (SW RECORD 7000 miles), including "Radiobuilder"—25c. Laboratories, Box 1-b, San Carlos, California.**

**LOUDSPEAKER WILL PLAY ON CRYSTAL DETECTOR; handbook tells how—build your own. Send \$1; on arrival pay postman 99c plus postage. R. G. Middleton, 47-25 44th St., Woodside, L. I., N. Y.**

**ONE-TUBE RADIO PLAYS SPEAKER ON ALL localities; manual gives circuits, instructions. Send \$1; on arrival pay postman 99c and postage. R. G. Middleton, 47-25 44th St., Woodside, L. I., N. Y.**

**GOVT SURPLUS AMPLIFIER. IN 4" x 4" x 8" BLACK wrinkle finished case, brand new, with tubes, input to 7F7, output 2-7C5's, full wave rectifier 7Y4, with transformer, all mica condenser coupling. Shipped in original carton. Parcel Post prepaid, \$4.95. Lyell Hardware and Lumber Co., P.O. Box No. 13, Rochester 11, N. Y.**

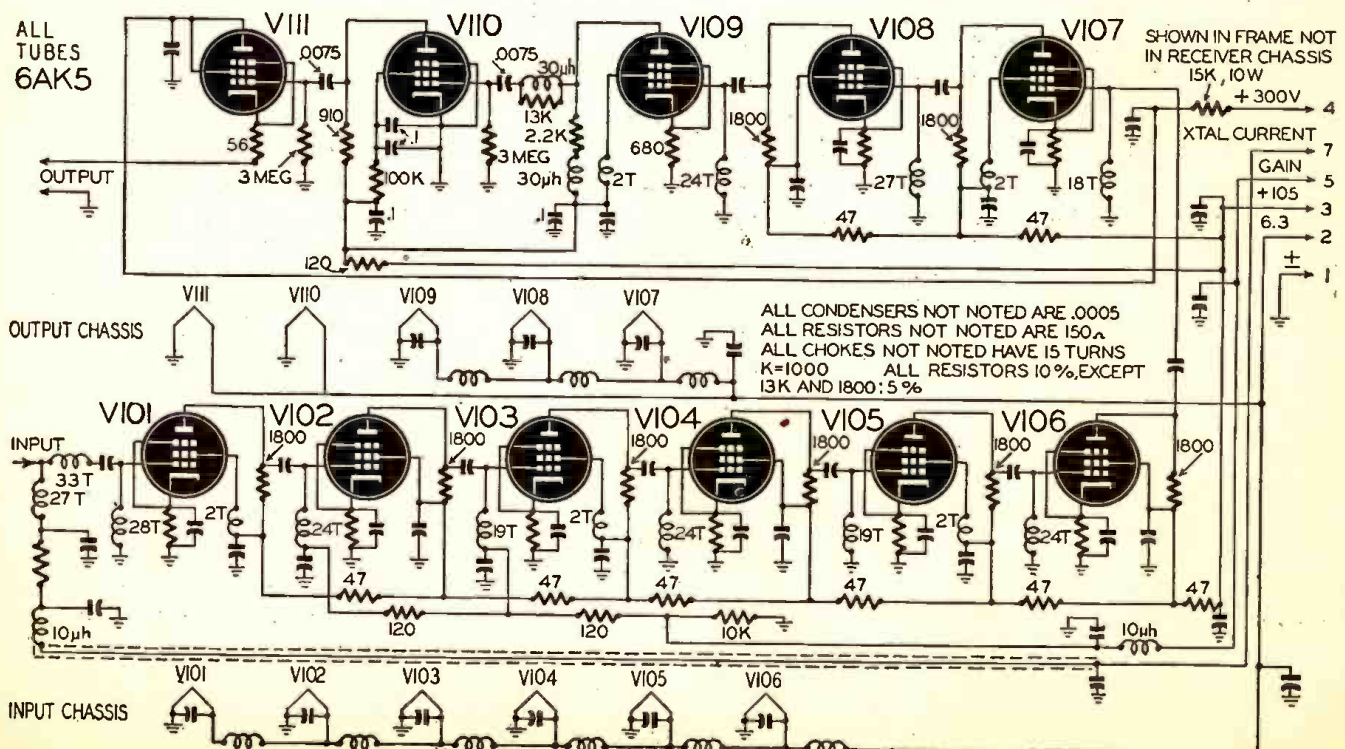

# "TAB"

That's a Buy



**ELECTRONIC VOLT-OHMMETER BRAND NEW U. S. ARMY TYPE I-107-F PRECISION UNIT.** Rugged design housed steel case 6"x9 1/2"x4 1/2" leather carrying handle. Contains Simson 4" highly damped 400 microamp Alnico meter. Clear visible scale, large numerals, easily readable at all points. All voltage ranges ten megohms sensitivity; reads 0-3 volts in .05 v steps; 0-10 volts in .2 v steps; 0-300 volts in .5 v steps; 0-100 volts in .2 v steps; 0-300 volts in 5 v steps—OHMS Rxl from .02 to 1000 ohms; Rx10 from 2 to 1000 ohms; Rx100 from 20 to 100,000 ohms; Rx1000 from 200 to 1 megohm; Rx10,000 from 2000 to 10 megohms (center scale is 10.) Unit complete with 3 test leads; batteries and instructions. Cost gov't \$65. "TAB" special \$29.70. Additional V.T.V.M. Local tube 1 LE 3/SP Sig C \$1.15.

CONDENSER WE new uprt.mtg. 500MFD-60WV	.95
CONDENSER WE oil 16MFD-400V Two for	2.35
CONDENSER KIT 24 midget oil Cornell Dub.	
8 each size 1&2&3 x .05MFD-300WV Gvt. Ins.	2.40
COND. GE pyranol 4MFD-600VDC wkg 2 for	1.90
COND. GE pyranol 2MFD-2000VDC wkg 2 for	4.25
CND. Wstphse 2MFD-5500VDC wkg (LP575)	12.50
COCKET Heavy duty 50 watt steelite Ins. 2 for	1.70
SOCKET Amphenol safety UX 77A-47N 10 for	3.00
SOCKET DiHeptal C-Ray & mtg.ring HF ins. 1.15	
CRYSTAL diode IN21 & holder Two sets ea. for	1.25
DUAL Condr. Var. 2-10mmf H. V. ....	.69
CATHODE Ray Tube new gv't. insp. 3BP1	6.95
1THODE Ray Tube new 5AP1, BP1, BP4	9.95
RECTIFIER GE 872 new G'Insp. (LP57.50)	4.50
WE J15V600ppl, 650VCT300ma: 5V3A: 6V5A	3.95
CRYSTAL & HOLDER LO DRIFT out any	
freq. 2199MCS active osc. gld. @ \$1.75, 4 for	6.10
CRYSTAL 1" aircraft 1000KC Std. .02% accy	7.20
Jennings VC vacuum condr's 50MFD-2000V	3.50
866A new G'Insp @ \$1.45, two for	2.79

Oscilloscope Conversion Kit BC 412 contains all parts for sweep circuits including diagrams. \$15.75  
Additional engraved dialplates. 3.75  
Complete kit all parts and dialplates. 18.50

Elmac 304TL used L.N. tested guaranteed	\$13.95
6J4 Tube RCA new gv't. insp. (LP58.35)	2.49
Micro wave ant. with coaxial enter. & mtg brkt.	.95
F.M. Television Rotatable UHF coupler.	3.95
Micro-Switch leaf type 10A. 125V SPNO 3 for	1.00
G.E. DW 44 R.F. Thermomtr 0-1A, 2 1/2" B' Case	3.85
Condenser tube dual 40 MFD 150WV thirty for	7.95
Elmac or HK VT 127A with connectors	4.95
DAVEN SWITCH 13 circuits 25 amp. etc. 2 for	.98
HEINEMAN mag. circuit bkr. 20A of 3A	.97
RELAY sen. sigma 5AH 200 ohm 3.5 ma SPDT	2.25
Relay Sensitive WE. 3500 ohms. SPDT 5A	.97
RELAY 105 Ward 1 115V60CY 20A Cts.	1.90
SHOKE G.E. 4HV 1/2 A. 30 ohm wt. 10 lbs.	2.95
TRANSF. 115V60C pri. 5V26A Sec. H.v. ins.	3.75
DC. VOLTMTR. G E 2000V 1000 ohm 2 1/2"	
B'C 1/2"	8.95
DC. VOLTMTR. 301 Weston 4000V 1000 ohms	10.95
DC. VOLTMTR. 301 Weston 10000V 1000 ohm	12.95
AC. VOLTMTR. NA33 Weston 150V 2 1/2" B'C	2.95
GE DC DNI miniature 1ma G'Insp. 1 1/2" B'C	3.25
COND. GE pyranol 3MFD1000VDC WKG 2 for	2.50
CONDOR Aerovox oil 1MFD1000VDC wkg.	36.00
CO-Axial 52&72ohm RG8&11u cable 100 ft.	12.00

**TRANSFORMER HIGH VOLTAGE**  
Brand New Kenyon 115v. 60cy. sec. 3200v.  
1/2amp. Bargain "TAB" Price \$9.75.  
Ship. wt. 40 lbs.  
Two units 6400 v. 1/2amp. C.T.  
"TAB" priced \$18.

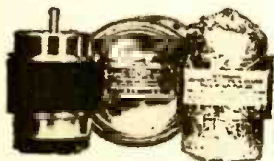

### AUTOSYNS BENDIX

Brand new gov't sealed and inspected packed in overseas cans. synchro-transmitters AC. 115v. 60 cy. operation. Continuous heavy duty. Precision accuracy made for gun-fire control. Cost gov't \$90 each. Wt. 5 lbs. each. "TAB" special two for \$18.

\$1 Min. orders FOB. N.Y.C. Add Postage all orders and 25% deposit. Whitehall 3-3557. Send for catalog 300. Don't wait, rush orders as quantities are limited. Buy thru "TAB" and save.

"TAB," Dept. RC6

Six-A Church Street, New York 6, N. Y.

## Available Radio-Electronic Literature

Manufacturers' bulletins, catalogs and periodicals.

**A SERVICE FOR RADIO-CRAFT READERS:** In order to save your time, postage and incidental work in writing a number of letters to different manufacturers to secure the various bulletins offered, proceed as follows:

On your letterhead (do not use postcards) ask us to send you the literature which you designate. *It is only necessary to give us the numbers.* We will then send your request directly to the manufacturers, who in turn will send their bulletins or other literature directly to you.

### 224—THE LIGHTHOUSE TUBE

Published by General Electric Company. The story of the new disk-seal electronic tube, known as the "Lighthouse Tube" and its specifications are given in publication ETR-7. This pamphlet describes the basic principles of design and operation of the tube and its advantages in the fields for which it is designed. The tube, now released from war applications, will be applied to television, FM radio and other fields in the ultra-high frequency spectrum.—*Gratis to interested parties*

### 225—THERMOCOUPLE DATA BOOK

Bulletin S2-6, published by Wheelco Instruments Company. A 31-page booklet of data on thermocouples and accessories. Complete with engineering drawings of all types of thermocouples. This data book may also be used as a catalog of the equipment and accessories handled by Wheelco Instruments Co.—*Gratis*

### 226—CANNON CONNECTORS

Sixty-four pages of material on many types of connectors, dust caps and receptacles is available in bulletin "K," published by Cannon Electric Development Co. This bulletin is illustrated and complete with dimensional drawings.—*Gratis*

### 227—SHALLCROSS CATALOG

An eight-page booklet describing the types of precision resistances and decade boxes available from the Shallcross Manufacturing Co. This catalog is of interest to electrical engineers, physicists, and manufacturers of electrical equipment.—*Gratis*

### 228—HIGH VACUUM EQUIPMENT

An interesting catalog by Distillation Products, Inc. Of interest to electronic engineers and physicists. It lists the various types of vacuum pumps and gauges necessary for high-vacuum work.—*Gratis to interested parties*

### 229—OHMITE CATALOG

A 16-page catalog published by Ohmite Manufacturing Company. Lists wire-wound resistors available from 1 to 200 watts with rheostats running to 500-watt capacity. Also included are volume controls, including special types, r.f. chokes and dials.—*Gratis*

### 230—KENYON TRANSFORMERS

A general catalog of transformers manufactured by Kenyon Transformer

Co. The transformers listed are those applicable to practically all phases of radio and electronic work. This catalog includes five pages of charts and graphs of value to the engineer or serviceman.—*Gratis*

### 231—REED FREQUENCY METERS

Bulletin 1770 contains 16 illustrated pages describing the Frahm Vibrating-Reed Frequency Meter as manufactured by James G. Biddle Co. These meters are manufactured in switchboard, portable and miniature models.—*Gratis*

### 232—LABORATORY OHMMETERS

Precision ohmmeters described in Bulletin 1805, published by James G. Biddle. These instruments are of interest to electrical engineers as well as telegraph and telephone maintenance men.—*Gratis*

### 233—PIEZO-ELECTRIC CRYSTALS

A seven-page catalog, of interest to engineers and amateur experimenters, issued by Crystal Research Laboratories, Inc. It describes the various types of crystals developed by the firm. Crystals are available for all applications, including supersonics.—*Gratis*

### 234—ELECTRICAL THEORY

Part 3 of a series on the theory and applications of electronics is published by Kuhlman Electric Co. This well-written booklet is illustrated with vector analysis diagrams of oscillators and other circuits.—*Gratis*

### 235—RECORDING DEVICES

A seven-page catalog, issued by Production Instrument Co. Includes a number of counters which have many applications in production. These counters are made to indicate the number of units or pulses produced as well as the number of revolutions or turns that have been applied to a coil-winding machine. Time totalizers and switches for actuating electric counters are also included in this well illustrated catalog.—*Gratis*

### 236—PLUG AND SOCKET CATALOG

An illustrated catalog of sockets and plugs applicable to radio and electronic equipment, published by A. W. Franklin Manufacturing Company. The illustrations of sockets and plugs are accompanied by working drawings and descriptive material.—*Gratis to interested parties*

## TWO DIMENSIONAL RADIOS

(Continued from page 643)

In actual construction, the resistors are printed on one side of the plate and the condensers are wired to the other. Fig. 2 shows the method of connecting the portions of the circuit on opposite sides of the plate. For clarity, the parts have been drawn in symbolic form between the connecting points.

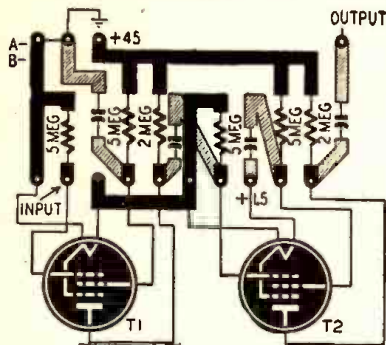

Fig. 2—"Wiring Diagram" for printed radio.

This new method of circuit design makes it possible to print coils for ultra-high-frequency circuits directly on the plate. Such coils have a Q of 150 to 200.

Although this technique is not applicable to the production of complete receiving or hearing aid sets, it may well be applied to unit portions of the circuits, such as resistance coupled amplifiers and simple control circuits. The small units may be replaced in a defective circuit almost as easily as a tube is changed today. The effects of this type of construction may soon be seen in smaller radios and hearing aids which will be more reliable and more easily serviced than the best sets today.

## R.F. POWER SUPPLIES

(Continued from page 616)

lished in the *Proceedings of the I.R.E.* April 1943. Sylvania pointed out the possibilities of such a circuit in connection with their 28D7, a tube intended to work with a plate voltage of 28 to 32. (*Sylvania News*, Jan, 1944.) Curves showing an output voltage as high as 200 (at 1 milliamper) and currents as high as 6 milliamperes (at 100 volts) were shown; plate input in each case being 28 volts. An article on this type of power pack appeared in the August, 1944 issue of *RADIO-CRAFT*, with a 25A7 instead of the 28D7 which was not easily obtainable, at least at that time.

There would appear to be definite field for power supplies of this type in a number of applications where moderate current is required, whether the voltage be high or low.

Two types of dry cell batteries developed by the U. S. Army Signal Corps during the war, replace nearly the entire line of dry cell batteries for low temperature operation. These batteries operated reasonably well down to 40 degrees below zero.



This Metal Container FREE

A J.F.D. CREATION FOR JOBBERS & SERVICEMEN  
Standard Equipment with Set Mfgs.

- Because:
1. Smooth Buna S synthetic rubber on outside cover
  2. Rough finish on inside
  3. Resistant to atmospheric changes
  4. Positive grip on shafts and pulleys

Packed in servicemen's kit of 25-50 & 100 belts  
The sturdy metal container and 64 page belt manual and measurement chart FREE with each kit.

USE THE BELT THE MFGRS. USE.

NOTE TO SERVICEMEN:

64 page Belt Manual FREE for the asking

J · F · D · MANUFACTURING CO.

4111 FT. HAMILTON PARKWAY · BROOKLYN 19, N. Y.



## UNIMETER

This unit fulfills an extremely important need for general utility portable service equipment. It has wide range coverage for both a-c and d-c measurements of voltage, current measurements on d-c and the popular ranges on resistance.

The UM-3 is designed to clearly indicate all the functions which aid in the prevention of application of high voltages when preparing for current or resistance measurements.

Other G-E units for better servicing include: Tube Checker TC-3, Unimeter UM-4, and Oscilloscope CRO-3A.

For details write: *Electronics Dept., Specialty Division, General Electric Company, Syracuse, New York.*

Electronic Measuring Instruments

GENERAL ELECTRIC

UM-3



**IT'S NEW!**  
**EXCLUSIVE!**  
**READY NOW!**

**WRL GLOBE TROTTER  
TRANSMITTER KIT**



25 Watt Output  
**The Sensation  
of the Year!**

Cat. No. 70-300 **\$59.95**

Complete including all parts, chassis panel, streamlined cabinet, less tubes, coils, and meter.

Cat. No. 70-312 Kit same as above, wired by our engineers **\$75.00**

Complete kit of 8 tubes Cat. No. 70-314 **\$5.95**

3 in. meter Cat. No. 70-318 **4.95**

Coils, per set, any band Cat. No. 70-316 **2.95**

Crystals, 40-80 meters, mounted Cat. No. 70-322 **ea. 2.65**

Quality crystal mike and stand Cat. No. 70-320 **9.45**

Here is the latest, most outstanding transmitter value on the market today. The WRL Globe Trotter is capable of 25 Watts output on all bands from 3500 KC through 28 Megacycles. Incorporates the Tritet Oscillator using a 40 metal X-tal and providing sufficient drive at 10 meters for the 807 final; Heising choke modulation; three bands, all returned; 10, 20, and 80 meters; metering provided for both oscillator and final stages; two power supplies, one for 807 final and modulator tubes, one for speech amplifier and oscillator stage.

**RECEIVERS**



**Extra Special  
NEW BC 348Q  
SURPLUS  
RECEIVERS**

Including Steel case, less speaker **\$85**  
Cat. No. 35-61

Here is one of the hottest war-surplus receivers that will be available, 9 tubes, 2 RF stages, 3 stages of IF amplification. Frequency range, 200 to 500 kilocycles; 1 1/2 to 18 MC in four bands. Weather and aircraft bands, and all ham bands, except 10 meters.

Here are just a few of the many well-known receivers offered by Leo:

Hallcrafters S-38 **39.50** Hallcrafters SX-25 **94.50**

Hallcrafters S40 **79.50** Hallcrafters SX-28A **223.**

RME 45 **186.** Hallcrafters S41G **33.50**

National NC 2-40C **225.** Hammarlund HQ-129X **129.**

Trade-in plan and easy terms

**SERVICE DEALER NEEDS**



**WRL MULTITESTER**  
Steel case with 30-60% angle **\$1875**  
Cat. No. 16-491  
Less Leads...

Handles AC DC Voltmeter, DO Milliammeter, high and low range Ohmmeter. 3" meter with sturdy D'Arsonval movement. Size 5 1/2 x 8 x 3 1/4.

A complete stock of tools, replacement parts, test equipment, intercom and public address systems... everything for the progressive service dealer.

**FREE! OUR LATEST FLYER**

Packed with real buys in radio, electronic, and general merchandise.

Giant Radio Map (size 3 1/2 ft. x 4 1/2 ft.) **..15c**

Handy Tube-Base Calculator **..25c**

Address Dept. RC-6 Council Bluffs, Iowa

World Radio Laboratories, Incorporated

Formerly Wholesale Radio Laboratories

World Radio Laboratories, Incorporated

World Radio Laboratories, Incorporated

World Radio Laboratories, Incorporated

World Radio Laboratories, Incorporated

World Radio Laboratories, Incorporated

World Radio Laboratories, Incorporated

World Radio Laboratories, Incorporated

World Radio Laboratories, Incorporated

World Radio Laboratories, Incorporated

World Radio Laboratories, Incorporated

World Radio Laboratories, Incorporated

World Radio Laboratories, Incorporated

World Radio Laboratories, Incorporated

World Radio Laboratories, Incorporated

World Radio Laboratories, Incorporated

World Radio Laboratories, Incorporated

**REDUCING HUM LEVELS**

(Continued from page 619)

The speaker field resistance in Fig. 2 might be, in many cases, 400 to 500 ohms. If a low resistance choke having a d.c. resistance of 80 or 100 ohms is put in the circuit, as shown in Fig. 3, the d.c. voltages will not be affected to any considerable extent but the hum level will be greatly reduced. The choke alone will help in reducing hum, but if an extra filter is added, C<sub>3</sub>, which may be 16- $\mu$ f, the hum will be still lower.

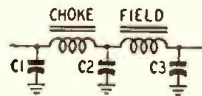

Fig. 3—A low-resistance choke will cut hum.

In a.c. sets using full wave rectifier power supplies, the hum output of the B supply may be very low since the ripple frequency is 120 cycles and the filtering can be made efficient. The hum due to an unbalanced filament circuit may then be more important. In Fig. 4, a tap is used on the filament winding and may give satisfactory results with such tubes as the 45, 47, 2A3 and 6A3. An improvement will sometimes be possible if a centertapped resistor or a potentiometer arrangement is used. In Fig. 5, the use of a potentiometer is indicated, permitting an electrical balance in the filament circuit.

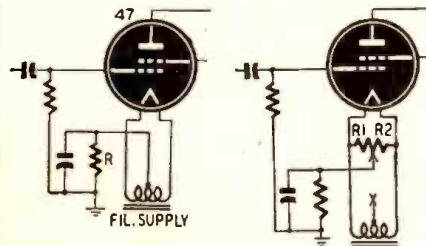

Fig. 4 (left)—Hum may arise from an off-center transformer tap in older receivers.

Fig. 5 (right)—The centering resistor was well known as a "humdinger" in its heyday.

In many sets, a push-pull output is used. A common cathode resistor is employed and no attempt is made to get a good balance in the output stage—essential for minimum hum and distortion. By using separate, adjustable resistors, as shown in Fig. 6, the balance and correct bias voltages are obtained. The maximum resistance of each bias resistor, that of R<sub>1</sub> or R<sub>2</sub>, would be about twice the value of the original cathode resistor. C<sub>6</sub> and C<sub>7</sub> are not very critical in capacitance values and could be rated at 20- $\mu$ f and 50 volts each. Condensers rated at 150 volts could also be used. The cathode resistances would be adjusted until equal plate currents, I<sub>1</sub> and I<sub>2</sub>, flowed in the primary of T. The currents would be indicated by low resistance d.c. milliammeters placed in series with each half of the transformer.

**LOW RESISTANCE CHASSIS**

The importance of using a low resistance chassis can be seen by referring to

Fig. 7. In some sets, one side of the filament winding is grounded to the chassis, say at point 1. The filament of the amplifier tube VT may be connected to chassis ground at point 5 and directly to the winding, C, at 7. If the chassis resistance between 3 and 4 is appreciable, a hum voltage may act in series with the grid of the amplifier tube and be greatly amplified, especially in high-

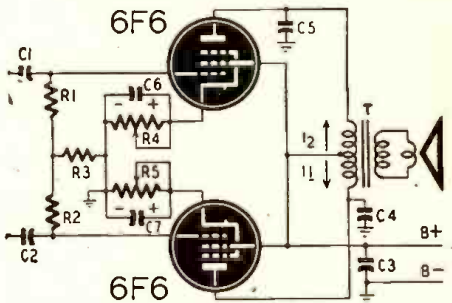

Fig. 6—Individual bias for push-pull tubes.

gain circuits. If the circuit is an r.f. type, hum modulation of the r.f. may result and then the hum will be heard due to the demodulation action of the second detector. By placing the grid return at 3, close to 4, a hum reduction may be found in some cases. Also, running a wire from 1 to 5 may prove helpful, instead of depending on the chassis as a conductor for the filament circuit hum current. Similarly, running C<sub>1</sub> not to point 2 but directly to point 1 is good practice. C<sub>2</sub> should not go to 6 but to 1. In this way, stray chassis currents can be reduced. Too many servicemen, in putting in a filter condenser, just look around for any old place to hitch the replacement unit instead of giving some thought to the matter. Note that the condensers in the primary circuit of the power transformer should be connected to a common point on the receiver chassis. If they are connected to two different points, hum may be heard.

Another important factor is an equal reading for each plate of the rectifier when testing the tube. The readings should be reasonably close together, a variation of 10% being maximum. If the plate readings are not equal, the rectifier tube should be replaced. An unbalanced rectifier may put out a 60-cycle hum plus harmonics. With the decreased ripple frequency, the filters are less effective and the hum level goes up.

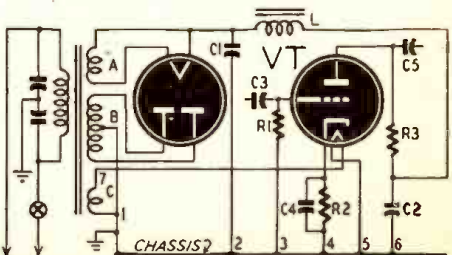

Fig. 7—Grounds to chassis may be important.

?? WHY NOT ??

Have you ever asked yourself, "Why can't I have this or that gadget on a radio? Why aren't programs made to fill such and such a need?" If so, you are a charter member of the *Radio-Craft* "Why Not" club. Send us your "Why Not's" on all subjects—serious or screwball, practical or idealistic. We will pay \$1.00 for every one we believe will interest the readers of *Radio-Craft*. You can get the idea from the "Why Not's" printed below. Send in as many as you like. One dollar will be paid for each one printed.

Why not have the manufacturers make speaker cones out of a thin plastic material that won't tear?

DAVID STRICKLAND,  
Pensacola, Fla.

(Some cones already have been made in full plastics, as well as plasticized fabrics. No doubt they will come into general use soon.—*Editor*)

Why not imbed magnetic wire recordings in paved roads at danger spots and then equip autos with magnetic pickups so verbal warnings and directions can be given?—

E. E. YOUNGKIN,  
Altoona, Pa.

Why not have the sound engineers of all the picture-producing companies print the picture sound tracks to the same level? Then the operator in the projection booth would not have to set the amplifier volume control whenever he changes from one reel of the picture to another.

DAVILO R. REYES,  
Gambou, Canal Zone

Why not give us a few articles on cabinet designs? Surely a lot could be said about reaction to heat and audio-frequency response of plywood, ordinary wood, plastics, and metal. Some radio experimenters build their own cabinets as well as what goes into them.

LUDWIG FURTH,  
London, England

Why not install home recording equipment in television sets for the purpose of recording a television program's video signal? Then with a flick of a switch whole television programs may be recorded on phonograph records. The voltage fluctuations which affect the electron beam in a cathode-ray tube can easily be impressed on a record, and when the record is played back these voltage fluctuations are reproduced and applied to the plates of the tube. It might also be interesting to play this record of a picture on a regular sound phonograph; then we could hear what a picture looks like.

MORTON LUTZKY,  
Brooklyn, N. Y.

[The wide frequency band required by a video signal (as high as 2½ or 3¼ mc.) cannot be recorded on any existing recording system.—*Editor*]



# Glaub Xtals!

## Amateurs...

DO YOU know where you are in the Radio Spectrum? With a Glaub Xtal you can be sure. Our Xtals are ground to within .03% of specified frequency and guaranteed, with a temperature coefficient of less 3 cycles per megacycle per degree centigrade. They can't be beat! Attractive, convenient holders to fit any set. A custom built Xtal to your specifications at a standard price.

DELIVERED 48 HOURS AFTER RECEIPT OF ORDER  
LET US PUT YOU IN YOUR PLACE ON THE AIR!

### PIONEER ELECTRIC COMPANY

Western Distributors of Glaub Crystals

3700 East Olympic Boulevard • Los Angeles 23, California

# PRE-EXAM TESTS

## For Commercial Radio Operator FCC LICENSE EXAMINATIONS



### Don't Take A Chance!

Avoid Failure On FCC Commercial Radio Operator License Examinations!

USE  
NILSON'S COMPLETE PRE-EXAMINATION TESTS  
AND COACHING SERVICE

Enables You To  
REHEARSE the FCC license examinations  
PRACTICE the procedure  
PRACTICE the multiple-choice examination methods used by FCC  
CHECK your knowledge  
LOCATE your weak points  
CORRECT your weak points before taking the actual examination  
Use Coupon or write for Descriptive Folder  
No obligation—no salesmen

### Cleveland Institute of Radio Electronics

Successors to Nilson Radio School, founded 1939;  
Smith Practical Radio Institute, founded 1934.

RC-6 TERMINAL TOWER CLEVELAND 13, OHIO

MAIL THIS COUPON

CLEVELAND INSTITUTE OF RADIO ELECTRONICS Approved for Veteran Training  
RC-6 Terminal Tower, Cleveland 13, Ohio Under "G-1 Bill of Rights."

Gentlemen: Please send information about Pre-Exam Tests.

Name .....

Address .....

City ..... Zone ..... State .....

If a War Veteran, Check Here

# 18 YEARS IN RADIO



**GET THIS  
New CATALOG  
By This Old Firm**

Latest developments in radio and electronic parts and devices, newest ham gear, gadgets for experimenters, bargains in war surplus items.

**FREE  
TO YOU**

Mail the coupon below and get this new catalog FREE.



BURSTEIN-APPLEBEE CO.,  
1012 McGee, Kansas City 6, Mo.

Send me FREE catalog advertised in  
Radio Craft

I AM \_\_\_\_\_  
STATE CONNECTION IN INDUSTRY

NAME \_\_\_\_\_

ADDRESS \_\_\_\_\_

TOWN \_\_\_\_\_ STATE \_\_\_\_\_

## Order from LAKE! You'll Make No Mistake! RADIO Cabinets & Parts



**NOW  
Available**

**Postwar  
2 Post**

**RECORD-  
CHANGER**

With luxurious brown leatherette portable case 15" L x 15" W x 10" D. Latest electronic developments make this modern record-changer the finest on the market today!

List Price.... \$49.95 Dealer's net.... \$29.97

Also blank table cabinets of walnut veneer in the following sizes, with speaker opening on left front side. (Note: 7" has center speaker grill.)

- #1 - 8 1/4" L x 5 1/2" H x 4" D \$1.95
- #2 - 10 1/4" L x 6 3/4" H x 5" D \$2.75
- #3 - 13 1/2" L x 7 5/8" H x 6 1/4" D \$3.25
- #7\* - 10 1/4" L x 7" H x 5 1/2" D \$2.50

\*Speaker Opening in center of front side.

All types of radio cabinets and parts are available at Lake's lower prices. A large stock is listed in our catalog.

**SERVICEMEN-RETAILERS**  
Join our customer list today.

Write for our NEW, 12-page, illustrated, elaborate catalog!  
Dept. C



**LAKE RADIO SALES CO.**  
615 W. Randolph Street, Chicago 6, Ill.



## TINY POCKET SIZE NEW RADIO!

Slips in your pocket or purse—Weigh only 3 ozs. Complete. READY TO PLAY as shown with self-contained phone for personal use. Smooth, durable black and silver plastic case. His patented Fixed Crystal—NO TUBES, BATTERIES OR ELECTRIC PLUG IS REQUIRED. USUALLY RECEIVES LOCAL BROADCASTS CLEARLY without outside aerial wire. GUARANTEED TO WORK when connected and used according to instructions sent with each radio. Can be used in homes, offices, hotels, cabins, bed, after hours, etc.

SEND ONLY \$1.00 cash, money order, check and pny postman \$2.99, plus delivery fees on arrival or send \$3.99 for postpaid delivery. IDEAL GIFT FOR CHILDREN OR ADULTS ALIKE! Get your PA-KETTE RADIO TODAY—NOW. Dealers in most cities.

**PA-KETTE RADIO COMPANY**  
DEPT. RC-6 KEARNEY, NEBRASKA

## "PORTARIG" HAM STATION

(Continued from page 612)

on the power unit to provide a link for the power cord between the transmitter-receiver chassis and the power chassis. As it was desirable to operate the set with the power unit about six feet from the transmitter, remote power switching is available from the panel of the transmitter when d.c. supplies are used. The filament pins of the socket are used to carry the d.c. because they are larger and will offer less resistance to the flow of current. Line voltage is controlled by a switch in the line.

Determining the correct values for the transformer buffer condensers is one of the most difficult tasks encountered in constructing a vibrator-type power supply. An oscilloscope is used to determine the correct wave form of the primary voltage. The ideal wave form that may be reached in practice is shown in Fig. 4-a. Wave forms caused by too much capacity will resemble Fig. 4-b while insufficient buffer capacity will give wave forms similar to 4-c. If an oscilloscope is not available a d.c. ammeter is placed in the battery lead and condensers changed till lowest amperage is registered.

"Hash" chokes are placed in the positive lead to the vibrators to prevent vibrator noises from being radiated. These chokes consist of 20 turns of No. 10 enamel wire wound on a 3/4-inch form.

to the front panel since it is pre-adjusted to give full output from the modulator when speaking close to the microphone in a normal speaking voice.

Selection of the a.v.c. and a.n.l. circuits is made by the A.N.L.-A.V.C. switch, S3 which is a two-pole, four-position rotary switch. It is possible to get either type of operation, or both combined, with this switch.

The PHONE-CW switch is a double-pole, double-throw switch, S4. When in the c.w. position, the plate voltage is applied to the plate of the b.f.o. tube and the r.f. power amplifier plate lead is shunted above the modulation choke.

A 4-gang-4 position switch, S5, is the Channel Selector. Sections "A" and "B" select the proper tuning condensers for the antenna and mixer coils of the receiver. "C" and "D" select the crystals for the receiver and transmitter oscillators respectively.

Antenna tuning is accomplished by C1 and C2, which are 100-μmf double-spaced midget condensers. They are connected across the ends of the tank coil, L4, in a "pi" network. The end plate of C2 is bent so that it will short the condenser when the plates are fully meshed. With C2 shorted, the circuit becomes a conventional shunt-fed tank. By

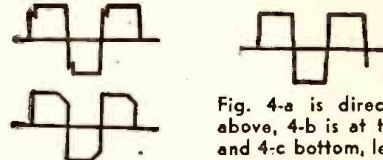

Fig. 4-a is directly above, 4-b is at top and 4-c bottom, left.

### COIL DATA FOR PORTARIG 80-METERS

- L1—(r.f. grid coil) 45 turns, No. 24 enamel, close wound.
- L2—(r.f. plate coil) 24 turns, No. 24 enamel, interwound with lower end of L3.
- L3—(Mixer grid coil) 45 turns, No. 24 enamel spaced.
- L4—(power amplifier plate coil) 54 turns No. 16 enamel, tapped at 20 and 30 turns.

Coils L1, L2 and L3 are wound on 1/4-inch forms, L4 is on 2/4-inch form.

Receiver ON-OFF switch, S1 is a heavy-duty double-pole, single-throw switch with the poles wired in parallel. When this switch is closed, d.c. voltage is applied to both vibrators and the receiver filaments. The transmitter ON-OFF switch, S2, is used to control the filament voltage to the transmitter. It is so wired that it is impossible to heat the transmitter filaments without turning on the receiver filaments and the "B" voltage.

The SEND-RECEIVE switch is a heavy-duty double-pole double-throw switch used to switch the antenna from the transmitting to receiving circuits and the phone jack from a.f. output to side-tone reception.

The volume control is a 500,000-ohm potentiometer in the grid circuit of the 6Q7.

The modulation control is a 500,000-ohm potentiometer connected across the grid winding of the input transformer to limit the audio level applied to the 6Z7 grid. This control is not brought out

using this method of loading the transmitter output circuit any single or double wire antenna may be matched without loading coils.

The tuning unit is a desirable feature when the set is to be used on widely separated frequencies. All of the frequency-determining elements of the set are mounted on a small chassis that has three 4-prong plugs mounted on its cover plate. These plugs are located so that they will match corresponding sockets mounted on the main chassis. Metal shield plates are fastened to the sides of the tuning unit to serve as guides when inserting the tuning unit into its sockets.

The crystals for the receiver are ground for frequencies 456 kc lower than the corresponding transmitting crystal. If it is desired to operate the transmitter on 3966 kc, for example, the receiver crystal will be ground for 3966 minus 456 or 3510 kc.

No troublesome microphone batteries are used because the battery voltage is obtained from a tap on the cathode resistor of the modulator.

The tubes selected for this rig proved to be unbeatable for operating in rough terrain under all conditions. The 6L6-G proved to be the outstanding tube as an r.f. power amplifier. On occasions 70 watts power input was used for c.w. operation and 50 watts phone without a blush from the plate.



**A METAL LENS**  
(Continued from page 602)

The necessary design theory was worked out in mathematical detail and systems of metal plates were subsequently built to duplicate the action not only of convex and concave lens but also of other optical devices, such as half and quarter wave plates and prisms.

The drawings compare an electronic lens with an optical one. Because the waves handled are an appreciable fraction of the diameter of the lens, some things can be done with them that cannot be paralleled with their glass counterparts. The concave lens elements, which consist of metal sheets, instead of becoming progressively wider toward the lens edges, as shown in the drawing, can be cut back every half-wavelength or multiple thereof, thus saving metal and making a lighter structure. The back of each metal plate thus resembles a huge saw, one side of each "tooth" following the lens curve, the other side straight and parallel with the lens axis.

**ELECTRONIC "NIGHT SIGHT"**  
(Continued from page 603)

plied by a storage battery, which, with the vibrator power pack which supplies high voltage for the image tube, is carried on the operator's back.

A soldier with a "sniperscope" (a "snooperscope" mounted on a carbine) was said to be more effective in stopping infiltration than 12 men with regular weapons. Here is how the infra-red carbine operates, as explained by an Electronic Laboratories official:

"A fighter armed with a sniperscope hears a sound. He points his weapon into the darkness, peers into the telescope, and turns on the power supply. He moves the weapon back and forth, like an invisible searchlight, his eye pressed to the telescope, until he sights the enemy, slowly crawling forward.

"The enemy soldier is unaware that he is impaled by a beam of invisible light of a greenish hue. (In the telescope all objects appear as various shades of green regardless of their color in daylight, due to the use of high-sensitivity green phosphor on the cathode-ray tube screen.) The U. S. soldier focuses his telescope quickly, lines up a bead on the enemy with the telescope sight, and, with a press of the trigger, there is one less infiltrating enemy."



**BEHIND YOUR CONSCIOUS MIND**

? Do you use just your thinking mind? If you ?  
? do, you are missing 90 per cent of your ?  
? possibilities. Those occasional hunches are ?  
? the urges of a vast sleeping force in your ?  
? inner mind. Learn to develop and direct it. ?  
? Push obstacles aside and master life with an ?  
? energy you have overlooked. Send for FREE ?  
? SEALED BOOK. It tells how to obtain ?  
? these teachings. Address: Scribe E.K.W. ?  
? **The ROSICRUCIANS** ?  
? SAN JOSE [AMORC] CALIFORNIA ?

**HAM HEADQUARTERS FOR**  
Equipment and Information

**SPECIALS**

- Low Loss Antenna Change Over Relay 6V. D.C. D.P.D.T.—\$1.75
- 3C/24G, Tubes—\$1.90
- 3.3 MFD—600V. Oil Filled \$0.99
- 8 MFD—600V. Oil Filled Round Can Any Mounting \$1.50
- 2 MFD—2000V. C.D. \$3.50
- Ceramic Caps for 807-866, etc.—\$0.19 ea.

Mail Orders Promptly Filled  
Amateurs to Serve You

(20% Must Accompany All C.O.D. Orders)

Write Dept. RC  
W6SCQ—W6UXN—W6NAT  
W6SSU

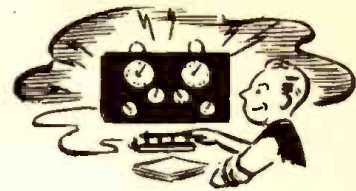

**FOR YOUR NEW RIG**

We Have a Good Stock of  
All Standard Lines

**\* SUPER BUY**

For 10 Meter F.M. Mobile Operator.  
RC 1335 COMPLETE TRANSMITTER and RECEIVER From 27.5—38.9 MC READY TO GO with 3 Crystals for FM Portion of 10 Meters and Shure T17B Hand Set. **\$53.00**

**Radio Product Sales Company**

238 WEST 15TH STREET

LOS ANGELES 15, CALIFORNIA

Prospect 7471

**SPEED UP REPAIRS WITH THESE G-C AIDS!**

**G-C is HEADQUARTERS for RADIO PARTS and SERVICE AIDS**



All Types of Radio Cements, Chemicals, Coil Dopes, Compounds

G-C leads the field in supplying Radio - Electronic Manufacturers and Service Men with Parts, Tools, Radio Cements, Chemicals and Compounds. Insist on Genuine G-C Quality.

FREE STEEL CABINET

Dial Cables, Dial Belts, Packaged Hardware, Cabinet Repair Kits

SPEEDEX Wire Strippers Alignment Tools Ne-O-Lite Testers

ORDER FROM YOUR JOBBER—SEND FOR G-C CATALOG



**GENERAL CEMENT MFG. CO.**  
ROCKFORD, ILLINOIS

**SERVICEMEN—HAMS**  
NATIONALLY BRANDED TEST EQUIPMENT & HAM RECEIVERS IN STOCK  
Complete Line of Tubes and Supplies  
RCA Replacement Parts and Power Tubes  
**CHIEF ELECTRONICS**  
Hudson Valley's Only Distributor  
104 MAIN ST. POUGHKEEPSIE, N. Y.

**Ted McElroy**  
World's Largest Manufacturer of Wireless Telegraphic Apparatus  
COMPLETE CENTRAL OFFICE EQUIPMENT  
**McElroy Manufacturing Corp.**  
82 Brookline Avenue • Boston, Massachusetts

# NIAGARA RADIO SUPPLY

## SAVE MONEY BUY THE NIAGARA WAY

*Remarkable Buy!!!*

**BEAT FREQUENCY OSCILLATOR**

Limited Quantity  
First come  
First served

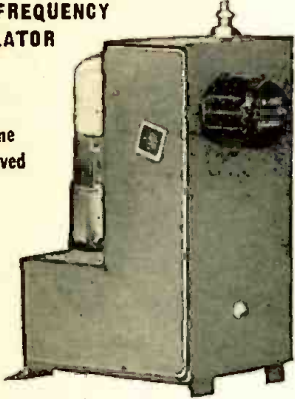

HUNDREDS OF USES

Can be used as C.W. OSC., Basic OSC for frequency meter, Signal Generator. Original frequency 372.6 to 415.7 with one Padder cut out becomes 456 or 465 KC. Comes complete with schematic, **\$3.95** hardware and 6J5 tube.

Wonderful Buy. This Meter has multirangers and shunts to build your own Volt-ohmmeter or Vacuum tube Voltmeter



Model 301  
Weston  
0-1 Mill Movement  
150 Ohm Internal Resistance

**\$8.95**

Includes the following parts:  
Shunts—7.9 ohms and .015 ohms.  
Multipliers—1% precision IRC 50,000 ohms, 200,000 ohms, 500,000 ohms.  
Fuse holder, Potentiometer, S.P.D.T. switch, 5 position 2 gang ceramic wafer switch, 2 phono jacks, 2 amphenol connectors.  
Black, crackle finish steel case.  
Dimensions 7" x 4" x 2".  
No additional parts needed to build a complete V.O.M.

**NIAGARA RADIO SUPPLY**  
160 GREENWICH ST., N. Y. 6, N. Y.  
BO-9-7993 Send for Bulletin A3

## WHY THE TUBE SHORTAGE?

(Continued from page 601)

of three tubes required for set production, or nearly 35 million tubes per year.

It now appears that the radio industry is geared up to produce some 25 million radio sets per year, if and when the necessary materials become available. With FM and Television in the postwar picture, it looks as if the requirements for the original equipping of such sets will increase to approximately seven tubes per set as against the 5½ tubes per set in the prewar period.

From the calculations of these trends and other factors involved, it becomes evident that radio dealers and radio servicemen in the United States alone will probably absorb approximately 100 million tubes per year. *These requirements would be three times greater than those of the prewar period, making it necessary for the serviceman to turn away two out of three customers.*

The radio tube manufacturers feel that it is in the best interests of the industry to serve the set manufacturer first, because basically the radio receiver has made and will continue to make the tube market. Not even a radio serviceman without a single tube on his shelf would contradict the axiom: "no receivers, no tubes." Another important point: it is better at this state of our national economy to produce a number of tubes to go into a new receiver, rather than produce them to repair a worn-out antique which should be junked on account of old age. *Consumers want tubes; but new sets too.*

For these and other reasons tube manufacturers feel that new receivers should have first call on tubes; and accordingly they have allocated their production on the basis of *three tubes per new radio receiver and one tube for replacement.* Radio receiver manufacturers are and will continue to be the biggest customers for radio tubes. This is true in normal times and today too.

It is idle to pretend that all, or even the greater part of the approximately three million tubes a month allotted to repair and maintenance reach the serviceman, even were these quantities actually produced at present. RADIO-CRAFT is well aware that large numbers of these tubes "disappear" through intermediate commercial channels on their way from the factory to the ultimate consumer, the radio serviceman.

Throughout the whole industry, it is too well known that small radio set makers—the so-called "bed-room manufacturers" have no credit standing with the tube manufacturers, who therefore won't sell them. But the small set makers—there are hundreds of them—move heaven and earth to secure the precious tubes. They make "raids" on wholesalers, radio stores, department stores—yes they even buy tubes from the larger service establishments at fancy prices! This is a feature—albeit an unlovely one—of the present economic setup, and one that apparently can be relieved only by time and the natural play of economic forces. The radio serviceman is no worse off in this respect than retailers in other fields.

After weighing all the facts, RADIO-CRAFT estimates that the tube situation will probably continue unsettled for the rest of 1946. There may be quite a bit of improvement toward the end of the year, but the situation will not become entirely normal till sometime late in 1947. This analysis is based on the premise that there will be no unpredictable political or industrial crises or bottlenecks which would introduce totally new and upsetting factors.

Taking all the facts into consideration, the only conclusion that can be drawn is that it will be some little time before the situation will revert to a prewar normality, with sufficient tubes available to meet all demands.

## RADIO TERM ILLUSTRATED

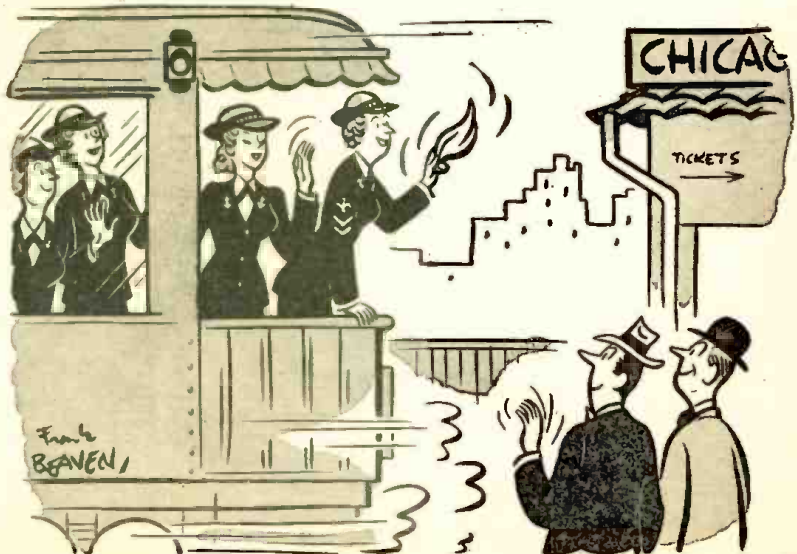

Suggested by: Quentin Piepergerdes, Kansas City, Mo.  
Wave Train

RADIO-CRAFT for JUNE, 1946



### Photo Electric Unit

For numerous control applications such as burglar alarm, industrial safety controls, automatic counters and in conjunction with a chime or bell to announce entrance of people in stores and offices. For AC.

Complete with all tubes and SPDT control relay. Net. **\$9.45**

**ADSON RADIO CO.**  
221 FULTON ST., NEW YORK 7, N. Y.

**BE YOUR OWN BOSS!  
MAKE MORE MONEY**



\$1.00 VALUE

**25c**

68 PAGES

40,000 WORDS

In "CASH IN" you now get THE real money-makers—dozens of profitable tested mail order plans, confidential business secrets, dozens of practical tested formulas, successful tested schemes—actual experiences of men who have started on a shoestring—with less than \$10 capital. 25c a copy postpaid. Send U. S. stamps, money order, or coin.

**MONEY BACK GUARANTEE**

**NATIONAL PLANS COMPANY**

P. O. Box 26R, Station N

New York 23, N. Y.

## HORN-IN-CONE SPEAKER

A loud speaker which is cone and horn in a single unit, has been developed by Jensen. The speaker is so constructed that the cone, which reproduces the low-frequency sounds, forms the horn of the high-frequency unit. Aptly named the Coaxial (Type H),



the new speaker is adapted to use in home radio receivers and phonographs, particularly for FM reception and high quality phonograph reproduction.

The Coaxial consists of two units, each reproducing a portion of the total frequency range. A compression-type high-frequency unit is attached to the back of a 15-inch direct-radiator low-frequency unit. The horn for the h-f unit is formed by a passage of expanding cross section through the core of the l-f unit, the carefully shaped diaphragm of the l-f unit forming a continuation of the h-f horn. The l-f diaphragm is driven by a conventional voice coil assembly.

The Coaxial speaker preserves the advantages of two-channel loud-speaker systems with "compression" or horn-type h-f units, while overcoming three major shortcomings of conventional two-way coaxial systems: (1) In the Coaxial, the mouth of the h-f horn is the full size of the l-f cone, thereby providing good acoustic loading in the vital cross-over frequency region. The horn mouth size is not compromised to reduce the obstacle the horn presents to radiation from the cone in the conventional horn-in-cone type.

(2) Since the cone of the l-f unit forms a smooth continuation of the h-f horn, there is no large multi-resonant cavity into which the h-f radiation can "spill over" nor into which the l-f unit can radiate. Objectionable resonances in the cross-over frequency region are therefore minimized.

(3) A special horn contour is used which gives much more uniform radiation over a broad angle than the conventional exponential type.

Electrical and mechanical cross-over networks are used which utilize the mechanical and acoustical properties of the two component channels in such a way as to yield optimum combined characteristics. Normally no control of the h-f response of the loud speaker other than that provided by the receiver tone controls, is necessary.

Additional h-f control may be provided by the use of an "L" pad. Alternatively, an "on-off" switch may be provided to cut out the h-f unit, although the resulting h-f response is not adequate for most purposes.

The "woofer" cone forms part of the horn for the "tweeter."

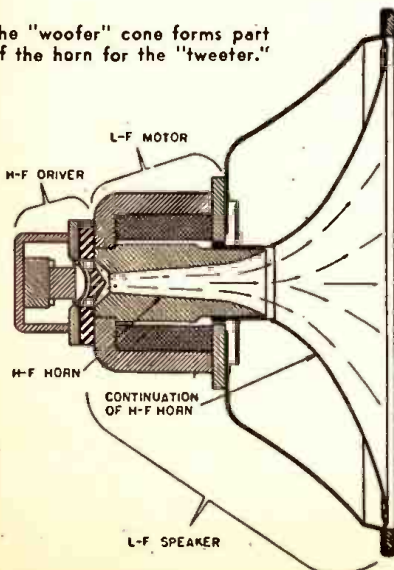

## Introducing...

REPLACES OLD-STYLE  
OVER-THE-HEAD PHONES

A revolutionary departure in headset design, the Telex "Monoset" is worn under the chin instead of over the head. Eliminates ear pressure and head fatigue. Weighs only 1.3 ounces. Adjustable to all head sizes. Rugged tenite construction. High Fidelity Performance. Frequency response 50 to 3,000 cycles. Sound pressure output 300 - 400 dyns per sq. cent. Available in three impedances - 128, 500 and 2,000 ohms.

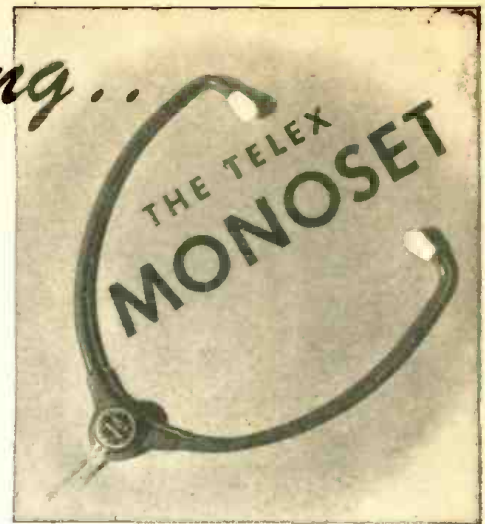

Territories Available  
Write for Particulars

**TELEX-INC.** ELECTRO-ACOUSTIC DIVISION  
MINNEAPOLIS 1 • MINNESOTA

## Electricity

Models range from 350 to 35,000 watts. A. C. types from 115 to 660 volts, 50, 60, 180 cycles, single or three-phase and 400, 500 and 800 cycles, single phase. D. C. types from 6 to 4000 volts. Also available in dual voltage and special frequency types.

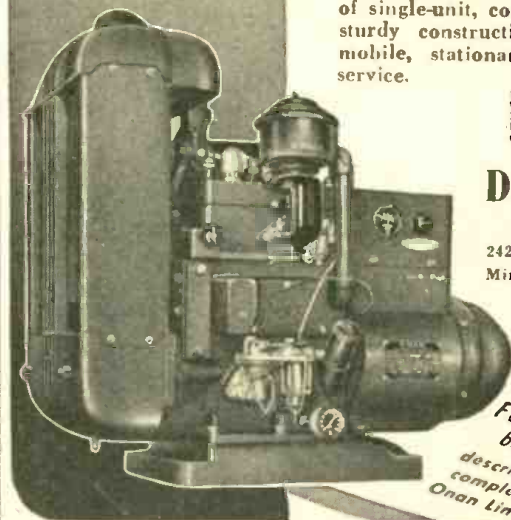

FOR RADIO AND  
ELECTRONIC APPLICATIONS

ONAN ELECTRIC GENERATING PLANTS supply reliable, economical electrical service for electronics and television applications as well as for scores of general uses. Driven by Onan-built, 4-cycle gasoline engines, these power units are of single-unit, compact design and sturdy construction. Suitable for mobile, stationary or emergency service.

Model shown is from W2C series; 2000 to 3500 watts; powered by Onan-built, two-cylinder, water-cooled engine.

**D. W. ONAN**

AND SONS

2429 Royalston Avenue  
Minneapolis 5 Minn.

Write  
For Folder  
690-A  
describing  
complete  
Onan Line

## Do you need BINDING POSTS?



The KL PUSH POST with its Spring Action assures Constant Contact and Quick connection.

Manufactured in All Aluminum Type M at 12c each.

Aluminum Body. Bakelite Top Type B1 at 15c each.

Types CP or NP. ALL BRASS-STAINLESS STEEL SPRING & PIN. PROVEN BY 240 HR. SALT SPRAY TEST as NON-CORROSIVE at 28c each.

Manufacturers and Dealers Liberal Discounts

**X. L. RADIO LABORATORIES**  
420 West Chicago Ave., Chicago 10, Ill.

# IMMEDIATE DELIVERY

## New Type SIGNAL TRACER



- \* SIMPLE TO OPERATE—only 1 connecting cable—NO TUNING CONTROLS.
- \* HIGHLY SENSITIVE—uses an improved Vacuum Tube Voltmeter circuit.
- \* Tube and resistor-capacity network are built into the Detector Probe.
- \* COMPLETELY PORTABLE—weighs 5 lbs. and measures 5" x 6" x 7".
- \* Comparative Signal Intensity readings are indicated directly on the meter as the Detector Probe is moved to follow the Signal from Antenna to Speaker.
- \* Provision is made for insertion of phones.

**\$1875**  
NET

MODEL CA-11  
Complete with  
Probe, test leads  
and instructions.

# ALMO RADIO CO.

## 509 ARCH STREET

LOMBARD 0513

Philadelphia 6, Pa.

## VIDEO AMPLIFICATION

(Continued from page 614)

Gain of a pentode video amplifier after proper compensation and where the plate resistance of the tube is large compared with the load resistance of the stage, is the product of the load resistor  $R_L$  and the tube's transconductance  $g_m$ .

Overloading of a video amplifier must be avoided. When this happens and the next stage is an amplifier, the grid of the following tube draws current and charges the coupling condenser  $C_0$ . If the charge is large enough, it may be sufficient to cut off the following stage—thus blocking the video amplifier until  $C_0$  becomes discharged. Since the value of  $C_0$  is dictated by the method of low-frequency compensation and cannot be made too small in value, the only remedy for overloading is extreme care in operation.

### TYPICAL CIRCUITS

Complete circuit of a typical video amplifier is shown in Fig. 1. Upper frequency limit of this circuit is about 4 megacycles.

A pentode—type 6AC7—forms the nucleus. It is operated sufficiently above cut-off to avoid the difficulty of partial limiting in the presence of strong input signals.

The input signal is applied through any suitable coupling arrangement to the grid of the pentode. Screen voltage is supplied through resistor  $R_s$ , which acts both as a filter and a dropping resistor. Plate load of the tube consists of a relatively low value of resistance.

High-frequency compensation is provided by both a shunt peaking coil  $L_s$  and a series peaking coil  $L_p$ . Low-frequency compensation is provided by the filter network consisting of resistor  $R_N$  and condenser  $C_N$ .

The network  $R_N C_N$  also serves as a decoupling network to prevent variations in supply voltage from influencing the performance of the pentode. However, it is usual to supply both plate and screen voltages of a video amplifier with a constant source of power.

All large by-pass condensers—electrolytics—are paralleled by small paper condensers for more effective by-passing action over the entire frequency band.

The amplified video output is applied to the next stage or device through coupling condenser  $C_0$ .

Another typical video amplifier circuit—of slightly different arrangement—is shown in Fig. 10.

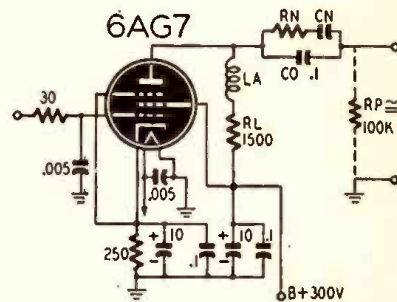
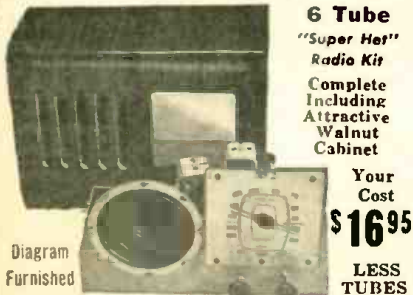

Fig. 10—Stage of a typical video amplifier.

The tube used is a type 6AG7 beam tetrode, operated in the conventional manner. Plate and screen voltages are supplied from a well-regulated source of power.

High-frequency compensation is provided by the shunt peaking coil  $L_s$ . Low-frequency compensation is provided by a filter network consisting of resistor  $R_N$  and condenser  $C_N$ , acting to increase the gain of the stage below about 200 cycles. At higher frequencies, the output of the video stage is unaffected by this network. Resistor  $R_N$  is non-inductive.

## LIBERTY RADIO KITS



6 Tube  
"Super Hot"  
Radio Kit  
Complete  
Including  
Attractive  
Walnut  
Cabinet

Your  
Cost  
**\$1695**

LESS  
TUBES

ALL PARTS MOUNTED—Uses one 25L6, one 25Z6, one 6SQ7, one 6SK7, two 6SJ7's or one 50L6, one 35Z5, two 12SJ7's, one 12SQ7, one 12SK7.

5 Tube  
"Super Hot"  
Radio Kit  
Your Cost  
**\$1395**

LESS TUBES  
Complete  
Including  
Attractive  
Brown Bakelite  
Cabinet  
Diagram  
Furnished

ALL PARTS MOUNTED—Uses one 25L6, one 25Z6, one 6SQ7, one 6SK7, one 6SA7 or one 12SA7, one 12SQ7, one 50L6, one 35Z5, one 12SK7.

10% DEPOSIT—BALANCE C.O.D.

**LIBERTY SALES CO., INC.**  
115 WEST BROADWAY · NEW YORK 13, N. Y.  
DEPT. K

VELOCITY P.G. DYNAMIC

THE FINEST MICROPHONES

# AMPERITE

FOR PUBLIC ADDRESS & RECORDING

MICROPHONES  
THAT SURPASS  
THE HIGHEST RE-  
QUIREMENTS OF  
BROADCASTING,  
PUBLIC ADDRESS,  
AND RECORDING

Write for Catalog

**AMPERITE COMPANY**  
561 BROADWAY · NEW YORK, N. Y.

Electrolytic by-pass condensers in the cathode and screen-plate circuits are paralleled, in the usual manner, by small paper condensers.

Output of this video amplifier is coupled through condenser Co to the next stage or electronic device.

Video amplifiers are widely used in television, since their wide frequency range makes them responsive to all picture signals.

Video amplifiers are used in the studio for amplification, polarity changing, and impedance matching—in order to preserve the wave form of the camera signals. They are used in the transmitter for amplification and modulation, and in the television receiver for polarity changing and amplification. Preserving the wave form of synchronizing pulses and blanking pulses are other duties performed by these amplifiers.

Radar employs video amplification in its pulse-forming circuits, much as such amplifiers are used in many industrial electronic devices. A frequency band-

width of at least three megacycles is necessary in order that a square or rectangular wave or pulse be amplified with negligible distortion.

Video amplifiers are also used in the final stages of a radar pulse receiver. One or more stages follow the second detector to amplify the rectified signal sufficiently to give proper deflection when applied to the plates of a cathode ray tube.

Although capable of considerable power amplification, video amplifiers are invariably operated as voltage amplifiers—since the load is normally connected to a cathode follower stage, or to the deflection plates of a cathode ray tube.

**ANOTHER NEWARK STORE!**  
AT 212 FULTON ST., NEW YORK 7, N.Y.

CHICAGO  
**Newark ELECTRIC Company**  
NEW YORK

115-117 W. 45th St. NEW YORK 19      323 W. Madison St. CHICAGO 6

**Choose the CANNON BALL HEADSET**  
**You Like Best**



Rugged construction. Inside or outside terminals. Sensitive, Clear tone. Dependable quality. Headset Headquarters guarantees satisfaction. Write for folder R-6.

**C. F. CANNON COMPANY**  
SPRINGWATER, N. Y.

**IMMEDIATE DELIVERY**

SPECIAL VALUES

COND. KIT # 1655 CONSISTING OF:  
5-20-20 Mfd. 150 V. & 25 Ass'd By Pass. 2.99  
BY PASS COND. KIT-20 Ass'd. 1 Watt. .99  
RESISTOR KIT-50 Ass'd 1/3 to 1 Watt. .99  
DIAL CORD KIT-100 Ft. Ass'd & 6 Springs. 1.10  
LOOP ANTENNA (High Gain) .59  
ANT. & OSCIL. or ANT. & RF. COIL SETS. .59  
OUTPUT TRANS.-2000.3 or 7000.3 Ohms. .59  
CRYSTAL PICKUPS-1 1/2 Or. 2.79

Write Today for Sarsain Bulletin  
RADIO DISTRIBUTING CO., Pasadena 18, Cal.



**1942 4 OUT OF 5 DIAGRAMS YOU WILL EVER NEED**

Find radio faults quickly. Make the needed repairs in any radio in minutes instead of hours. Save time on every job. These large, inexpensive diagram manuals have the circuit for every popular radio receiver. 4 out of 5 diagrams you will ever need are included.

**WITH ALIGNMENT DATA, PARTS LISTS**  
Clearly printed circuits, alignment data, parts lists, service hints are the facts you need to speed up servicing. Repair radios quickly and properly—follow the factory instructions given in these manuals. The 1942 manual lists 351 models of 40 manufacturers, 192 fact packed pages. Large size, 8 1/2 x 11 in. **\$2.00**

**1926-1938**



The most popular volume of the series. Will pay for itself with the time saved during the first day of use. Includes all the popular old timers. Save hours on every job. 427 diagrams of the most-serviced radios of this period, with parts lists and alignment information. 240 pages, 8 1/2 x 11 inches. **\$2.50**

**SAVE HOURS ON EVERY JOB**  
Be ready to make repairs in minutes instead of hours. You will be called upon to fix hundreds of models listed in these easy-to-use manuals. Tackle each job with the needed help found in these service manuals. Greatest bargain in diagram books. Send coupon today. Plan to use these manuals this week. →

**POPULAR, LOW-PRICED DIAGRAM MANUALS**

**1941** These easy-to-apply, inexpensive manuals will help you repair radios faster. This volume covers 1941 models, with alignment data, I.F. peaks, and replacement parts lists. Compiled by M. N. Beitman, radio serviceman for many years, author and teacher. Be expert in radio servicing; simplify your work. 192 pages, 8 1/2 x 11 inches. Only **\$2.00**

**1940** Let this important manual give you over 80% of all 1940 circuits you will ever need, acquaint you with new developments, train you to service quickly and efficiently millions of sets. Data on F.M., portables, recording, etc. 417 models of 43 manufacturers. 208 pages. Net price **\$2.00**

**1939** Another handy manual of most-popular diagrams you need. Circuit data, hints, and information are time-savers and money-makers for you. Let these diagram manuals guide you to easier service work. Why try to get along without helpful diagrams? Use this volume with 192 pages of popular diagrams of 89 manufacturers. Order today. Price only **\$2.00**

**Most Popular Models Made by:**

- Philco, RCA, Zenith, Sears, GE, Emerson, Belmont Radio, Detrola, Fada, United Motors, Westinghouse, Arvin, Majestic, Stewart-Warner, Admiral, Delco, Stromberg-Carlson, Western-Auto, Spartan, Wards, Motorola, Gamble, and many others.

**NO RISK TRIAL ORDER COUPON**

SUPREME PUBLICATIONS, 9 S. Kedzie Ave., Chicago 12, ILL.

Ship the following diagram manuals: (Money back guaranteed)

1942     1941     1940     1939     1926-1938

I am enclosing \$..... send postpaid.

Send C.O.D. I am enclosing \$..... deposit.

Name: .....

Address: .....

(Use Coupon or Write Order in a Letter)

**Supreme Publications**

PUBLISHERS OF RADIO BOOKS, MANUALS, AND DIAGRAMS

# FOR ALL Electricians

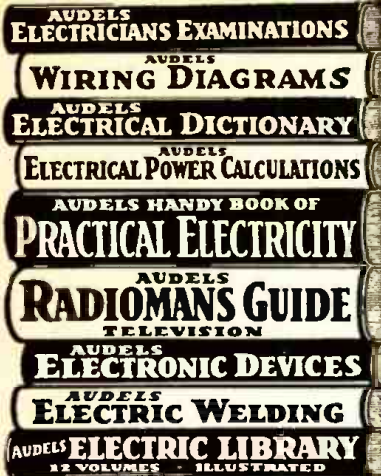

**PRACTICAL ELECTRICITY** at your finger ends. Answering your Questions and giving the facts and figures of your trade. Audels Electrical Guides contain Practical Inside Trade Information in a handy form. Fully illustrated and Easy to Understand. Highly Endorsed. Check the books you want for 7 days' Free Examination. Send No Money. Nothing to pay postman. If satisfied pay only \$1 a month until purchase price is paid.

ASK TO SEE THEM.



Get This Information for Yourself. Mail coupon today. No obligation unless O. K.

CUT HERE

## MAIL ORDER

AUDEL, Publishers, 49 W. 23 St., NEW YORK 10, N. Y.

Please send me postpaid for FREE EXAMINATION books marked (x) below. If I decide to keep them I agree to mail \$1 in 7 Days on each book, ordered and further mail \$1 monthly on each book until I have paid price.

- ELECTRICIANS EXAMINATIONS, 250 Pages . . . \$1.
- WIRING DIAGRAMS, 210 Pages . . . 1.
- ELECTRICAL DICTIONARY, 9000 Terms . . . 2.
- ELECTRICAL POWER CALCULATIONS, 425 Pages, 2.
- HANDY BOOK OF ELECTRICITY, 1340 Pages . . . 4.
- RADIOMANS GUIDE, 914 Pages . . . 4.
- ELECTRONIC DEVICES, 216 Pages . . . 2.
- ELECTRIC WELDING, 400 Pages . . . 1.
- ELECTRIC LIBRARY, 12 vol., 7000 Pgs., \$1.50 Each

Name \_\_\_\_\_  
 Address \_\_\_\_\_  
 Occupation \_\_\_\_\_  
 Employed by \_\_\_\_\_ RCF

## Attention!

Introducing  
Our First  
Post-War  
Radio Kit



Ideal for Use By

STUDENTS • SCHOOLS • HOSPITALS  
SERVICEMEN • AMATEURS

It uses the universally accepted superheterodyne circuit containing the following tubes: 12SA7, 12SK7, 12SQ7, 50L6, 35Z5 and tunes from 550 Kc. to 1600 Kc.

Model S-5 (Illustrated)—Complete Kit, including tubes, Bakelite Cabinet and four pages of diagrams and instructions . . . @ \$19.95

In addition, our previous models of meters and radio kits are still available.

Ohm-Volt Milliammeter Kit M-2 . . . @ \$14.95

Radio Kit model TRF-4-A, less cabinet . . . @ \$10.95

Radio Kit model S-6, less cabinet . . . @ \$17.95

25% Deposit on C.O.D. Orders

We carry a complete stock of parts. Export Inquiries Invited.

Write for FREE Catalog

**RADIO KITS COMPANY**

Dept. M 120 Cedar St. New York 6, N. Y.

# COMMUNICATIONS

## LETTER FROM A NETHERLANDS AMATEUR

Dear Editor:

This is a general call from the Dutch amateur station PA0CK, this time not by radio but in writing by letter with a kindly request, more a SOS than a request.

It is well known what has happened to us since 1940 in our small country with the German Army of occupation.

Many patriots lost their lives and a great part of the Dutch people their goods. In the Dutch Interior Forces (the Dutch "Maquis") I lost four friends by a raid of the German Police at our clandestine radio station (for contact with England). For a wonder I escaped and I am glad to live and to take care of my wife. The German S.S. made inquiries in our home but we had been warned and were not there. By our return all my electrical instruments, tools, photographic apparatus, wireless materials

and tubes and—last not least—all our linen had disappeared.

And now our troubles. By May we are expecting our first baby and now we have too few baby articles to receive our little stranger properly. My request to one or more radio friends is as follows: to help us with the baby articles which we need, as wool, little clothes, napkins, etc., but with the condition that I send back specific Dutch articles (possibly requested) so soon as it is possible for me to express my thanks.

Soon I hope to make contact by radio with the W . . . stations of the U. S. A. I am thanking you in anticipation for the trouble, help and this QSO and hope to receive QSL.

C. P. A. KANTERS, PA0CK,  
Dreibergenstraat, 4,  
The Hague, Holland

## WHERE IS ALL THAT YANKEE INGENUITY?

Dear Editor:

What I would like to see is more on how to use stuff out of the junk box. We overseas hear an awful lot about the great property of the Yanks to "make do" and improvise. Now let's see it in action! I would especially like to see articles on simple superhets and sets using one tube with multiple functions.

Some of us are still at school and haven't learned the mathematics you use in describing the technical points. I

know it can't always be done, but couldn't you give us a few simple articles now and then? Give us the fundamentals of things like negative feedback circuits and inverters? I was only a babe when those circuits first came out.

Anyhow I still think RADIO-CRAFT is the best magazine I know.

G. RANDLER,  
Natal, S. A.

## RETURNED SERVICEMEN'S LETTERS

Dear Editor:

The letter you printed from one of your readers on page 364 of the February issue makes me upset every time I think of it. This is putting it mild too. It seems to me he is working on the basis that the wheel that does the squeaking is the wheel that gets the grease. I think he is using the wrong type of squawk. He fought in the war, was disabled and is to be commended. I really would like to help the guy if I could. I didn't fight in the war, was on defense as an electrician for two years, but have been in radio since the time a Crosley Triadyne was de luxe equipment.

At times I feel the same way he does about the whole thing, but we can't control present conditions in five minutes. It may seem that the larger concerns are getting more than their share of supplies and attention, but in percentage we are getting as much, maybe more. I think everything will iron out all right, but it will probably take a considerable time.

By the way, Editor, you are to be commended for printing that letter. It shows that you are made out of the right kind of stuff.

CLAUDE M. PREW  
New London, N. H.

## ERRORS IN SUPER-REFLEX RECEIVER

Dear Editor:

I regret to inform you that the schematic of the "Super-Reflex Radio" as published on page 403 of the March issue contains two serious errors:

The resistor R5 is connected to the primary L3. It should be connected to the grid return of the secondary of L3 instead. As shown the high voltage is in the a.v.c. circuit.

The lead from prong No. 4 of the 7E7 is shown connected to the grid return of L3. This shorts the audio signal to

ground through C9. No connection should be made at this point.

I hope you can make an early issue with the necessary connections.

W. T. CONNATSER,  
San Francisco, Calif.

(Radio-Craft regrets the error, which is due in large part to the new and unorthodox nature of Mr. Connatser's circuit, which permits one tube to do the work of three, but leaves checkers of schematics in some doubt as to whether connections are correct or not.—Editor)

# Learn RAPID RADIO SERVICING

approved for  
Veteran Training

Our specialized training develops radio repairmen who have 200 hours actual servicing experience when they leave school. Course trains for AM, FM, Television, Broadcast and Amateur. This is no ordinary course. For particulars write:

IVAN D. LONG, President

## Western Radio Institute

1457 Glenarm, Denver 2, Colo.

In the Rocky Mountain Region it's  
RADIO & TELEVISION SUPPLY CO.

150 Hobson Ave., P.O. Box 892  
PUEBLO, COLO.

"If we don't have it, we'll get it—  
or it can't be had! Phone 5728"

## ROEHR DISTRIBUTING COMPANY

St. Louis' Radio  
Mail Order House

ANTENNAS (Auto and Home)  
CONDENSERS  
RESISTORS  
MICROPHONES  
TUBES

PHONO MOTORS  
BATTERIES

(All Types  
AB Packs)

PHONO NEEDLES  
TRANSFORMERS (All Types)  
VOLUME CONTROLS

(Complete Stock Carbon  
and wire wound)

ALL R. M. S. CABINETS IN  
STOCK

Write for our list of tubes  
catalog package, and informa-  
tion on how to secure a  
Speedex Tube Base Chart free  
of charge.

ST. LOUIS 3, MISSOURI

### A.C.-D.C. "B" BATTERY

THIS small power supply is not unusual as the simple diagram goes, but it was constructed like a 45-volt "B" battery, so as not to use up too much space in the battery compartment.

A 117Z6-GT duo-diode full-wave rectifier is expensive, but space was saved. The a.c. maximum plate voltage is 117 per plate and the tube has a heater current drain of .075 milliamperes with a d.c. output current of 60 ma per plate. The rectifier plates are connected in parallel, resulting in 120 ma maximum output and halfwave rectification.

The diagram of the portable "B" rectifier is shown in the figure. A single-pole single-throw thumb switch was placed in the line cord about two feet from the plug end so the rectifier could be turned off when not in operation. This switch can be omitted if the a.c. cord is pulled from the wall receptacle after the receiver has been switched off. The panel and switch on the battery receiver must still be used because the "A" battery will still be in circuit if the power supply's switch is "off."

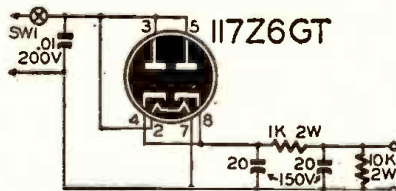

A small mounting strip was fastened to the bottom panel with 8-32 bolts and accessories. The a.c. line cord ends were soldered directly to this. Besides the mounting strip we placed a .01  $\mu$ f paper condenser to filter out all noise from electrical appliances on the power line. One side of the a.c. cord was not grounded through a condenser as usual to the metal chassis; no electrical connections were soldered to this metal case because a shock could be had from it to the ground.

The wafer octal tube socket is placed upside down and spaced from the chassis with two 1/2-inch fiber spacers. This made more space available for other components and lessened danger of shorting to metal chassis.

A 1000-ohm 2-watt carbon resistor in conjunction with a dual 20- $\mu$ f electrolytic condenser was used for filtering. This condenser must be placed as far as possible from the 117Z6-GT tube to avoid drying out the electrolytic solution. We figured, with about 117 volts output at the terminals of the cathode, the 1000-ohm carbon resistor would produce a voltage drop of 16 volts with 16 ma of current flowing through it. This current drain of 16 ma was the estimated drain of the battery receiver. This now leaves 101 volts on the output terminals of the power supply. To

(Continued on following page)

## TRUTONE

### SPECIAL Introductory Offer

10c per Pack, 12 for \$1.00 Postpaid

#### RADIO HARDWARE

Machine		Screws		Quan-	
Cat. No.	Size	Quantity	Cat. No.	Size	Quantity
501	4-36 x 1/4	16	508	8-32 x 3/8	12
502	4-36 x 1/2	16	509	8-32 x 1/2	12
503	4-36 x 3/4	13	510	8-32 x 3/4	11
504	6-32 x 1/4	15	511	8-32 x 1	7
505	6-32 x 1/2	14	512	10-32 x 1/2	10
506	6-32 x 3/4	12	513	10-32 x 3/4	8
507	6-32 x 1	8	514	10-32 x 1	6
Self Tapping Screws					
515	4 x 1/2	8	518	8 x 1/2	7
516	6 x 1/2	8	519	10 x 3/8	7
517	6 x 3/8	8	520	10 x 3/4	6
Metal Washers					
521	For No. 6	25	523	For No. 10	25
522	For No. 8	25			
Hexagon Nuts					
524	4-36 x 1/4	16	526	8-32 x 5/16	14
525	6-32 x 5/16	15	527	10-32 x 3/8	8
Lockwashers					
528	For No. 6	15	530	For No. 10	15
529	For No. 8	15	531	For No. 10	8
Assortments					
532	Wood Screws				10
533	Grommets				4
534	Cable Clamps				6
535	Dial Springs				2
536	Spade Bolts				7
537	Set Screws				5
538	Fibre Washers				15
539	Soldering Lugs				15
540	Rivets				15
541	Mounting Nuts				4
542	Grid Caps				4

We Can Supply All Types of Radio Hardware

WRITE FOR OUR COMPLETE CATALOGS

DEALERS Write for complete  
JOBBERs catalogs and discounts

TRUTONE PRODUCTS CO.

303 W. 42nd St., New York 18, N. Y.

famous for

## GREAT VALUES

Outstanding Offerings of

### NEW KITS!

PHONO KIT Consists of AC Phono Motor, Pick up, all parts necessary for 3 tube phono Amplifier, including 5" P.M. speaker. Excludes wire, solder and tubes ..... \$16.25

With the Above { PA-12 Portable leatherette-covered all-wood cabinet ..... \$7.95  
Kit of tubes ..... \$1.85

KIT #2 Easy-built 1 tube radio. Operates on AC, DC or battery current ..... \$7.05

All prices are F.O.B. New York City.

Write for our new catalog showing new test equipment, tubes and a large variety of new replacement parts. We ship anywhere in the U.S.A.—promptly.

RADIO DEALERS  
SUPPLY COMPANY

135 LIBERTY ST., NEW YORK 6, N. Y.

## OUTSTANDING VALUES

on top-quality merchandise  
Send today for free price list

**75 METER** transmitter and receiver. Army BC-654. Receiver is 7 tube superhet; transmitter is 6 tube. phone and CW with 25 watts output. Crystal calibrated. Perfect for marine or mobile use, as well as for Ham. Comes complete with 13 tubes, crystal, instructions, and circuit diagrams for \$9.95. Complete with Dynamotor high-voltage power supply, operating from either 6 or 12 volts—\$54.95. Send for free descriptive literature on surplus military electronic equipment.

**HIGH VOLTAGE CONDENSERS:** .5 Mr. 1000 WV G. E. Pyranol Oil condenser, 3.25 list, your cost, 75c. Triplo .1 Mr. 600V Cornell-Dubilier oil filled, list price 3.00, your cost 25c. Sragio dual—1.0 and .1 Mr. oil filled, list price 2.00, your cost .10c. 2 Mrd. Cornell-Dubilier, oil filled, list price 2.00; your cost .25c. These condensers are "naturals" for amateur equipment, public address systems, etc.

**CRYSTAL PICKUPS:** High-grade, nationally famous brand, feature low needle pressure and less record wear—now only 2.95. **LINE CORD RESISTORS**—Universal type—will replace line cord in any AC-DC set—65c. **LEAK AUTOMATIC BLOWTORCH**—Constructed of heavy brass, and comes to full heat in 15 seconds. Just the thing for those heavy soldering jobs—fine for out-of-doors work. Only 89c.

**CARBON MIKES:** "Home broadcast" type, complete with wire and instructions to attach to any radio—60c. **GOLD-PLATED** single button midgeet type signal corps mike—features stretched duraluminum diaphragm, waterproof construction and small size. Just the thing for concealed or secret pickups, lamp mikes, or for attaching to any radio. **SPECIAL—95c. SHURE** Model T-17, hi-quality single button mike with switch in plastic handle, cable and plug. The perfect mike for tank radios—2.75 ea. **Bullet CRYSTAL** mike—6.45; **Bullet DYNAMIC** mike, 7.45.

**MIDGET VARIABLE CONDENSERS:** For short-wave receivers, transmitters, etc. 25 MMF—39c; 50 MMF—49c; 75 MMF—49c; 100 MMF—64c; 140 MMF—69c; 3-Gang 350 MMF tuning condensers—85c. **LOOP ANTENNAS**, Standard type—30c.

**PAPER CONDENSERS**, guaranteed one year. Prices are in lots of ten, either one type or assorted: All 600 W.V., .25 Mr—20c; .1 Mr—10c; .05 Mr—9c; .02 Mr—8c; .01 Mr—8c; .008 Mr—5c; .005 Mr and smaller—7c. **MICA CONDENSERS**—All 1000V Test, 600 W.V.—any standard capacity—15c.

**TEST LEADS**—With red and black needle-point prongs—50c. **AUTOMOBILE ANTENNAS**—Standard 3-section type—60", 50", 36"—85c. **RECORD CHANGER**—110V, 60 Cy with crystal pickup. This modern two-post changer plays twelve 10 or 12 inch records **INTERMIXED!** The only changer on the market with this feature in its price range. Specially priced at 22.50. **AMATEUR CALL BOOKS**—New 1946 edition. Lists names and addresses of licensed amateurs all over the world—1.25.

**POWER TRANSFORMERS:** Half-Shell type, 110V, 60 Cy with center-tapped H.V. winding. Specify either 2.5 or 6.3V filament when ordering. For 4-5 tube sets—650V, 40MA, 5V fl. and either 2.5 or 6.3V fl. \$1.40 For 5-6 tube sets—650V, 45MA, 5V fl. and either 2.5 or 6.3V fl. 1.55 For 6-7 tube sets—675V, 50MA, 5V fl. and either 2.5 or 6.3V fl. 1.70 For 7-8 tube sets—700V, 70MA, 5V fl. and either 6.3 or two 2.5V fls. 2.05 For 9-11 tube sets—700V, 100MA, 5V fl. and either 6.3 or two 2.5V fls. 2.75 **FILTEK CHOKES:** Cadmium plated, 2" mounting; 200-300-400 or 500 ohms—49c. 30 HZ, 250 MA, 35 ohms, manufactured for U.S. Navy—fully shielded in black crackle case—1.98. Universal Output Transformer—tapped for various impedances—70c.

**RADIO SOCKET WRENCHES**—High-grade steel, practically indestructible. Each set consists of knurled handle and shank 7 1/4" long and 5 sockets; sizes 1/4, 3/16, 1/8, 1/16 and screw-driver socket, all fitting into handle. Special—79c set.

NOTICE: Minimum order accepted—\$3.00. Please enclose 10% deposit with all C.O.D. orders.

**BUFFALO RADIO SUPPLY**  
219-221 Genesee St., Dept. 6C  
Buffalo 3, N. Y.

## HAZELTON INSTRUMENT CO.

Electric Meter Laboratory

Electrical instruments, Tube Checkers, and Analyzers repaired.

140 Liberty St., New York, N.Y.  
Tel. Barclay 7-4239

**CRABTREE'S**  
**WHOLESALE RADIO**  
2608 Ross Ave.  
**DALLAS 1 TEXAS**

## INDEX TO ADVERTISERS

Adson Radio Co. ....	652
Aerovox Corp. ....	638
Allied Radio Corp. ....	633
Almo Radio Co. ....	654
Amperite Co. ....	654
Audel Publishers. ....	656
Bell Telephone Labs. ....	596
Buffalo Radio Supply Co. ....	658
Burstein-Applebee Co. ....	650
California Radio & Electronic Co. ....	627
Cannon Co., C. F. ....	655
Capitol Radio Eng. Institute ....	598
Chief Electronics ....	651
Cleveland Institute of Radio 631, 649	
Concord Radio Corporation ....	635
Crabtree Wholesale Radio ....	658
De Forest's Training, Inc. ....	595
Free Want Ad Service. ....	644
General Cement Mfg. Co. ....	651
General Electric Co. ....	647
Harrison Radio Co. ....	639
Hazleton Instrument Co. ....	658
Hudson Specialties Co. ....	659
International Resistance Co. ....	600
J.F.D. Mfg. Co. ....	647
Kwikheat Div., Sound Equip. Corp. ....	659
Kings Electronics Co. ....	636
Lake Radio Sales Co. ....	650
Liberty Radio Sales Co. ....	654
McElroy, T. R. ....	651
McMurdo Silver Corp. ....	641
Massey's Radio Supply ....	658
Metropolitan Electric Instrument Co. ....	629
Murray Hill Books, Inc. ....	621
National Plans Company ....	652
National Radio Distributors. ....	642
National Radio Institute ....	589
National Schools ....	597
Niagara Supply Corp. ....	652
Newark Electric Co., Inc. ....	655
Onan & Sons, D. W. ....	653
Opportunity Adlets. ....	645
Pa-kette Radio Co. ....	650

Panoramic Radio Corp. . . . . Back Cover  
Pioneer Elec. Co. . . . . 649

## RADIO SCHOOL DIRECTORY

(See Page 660)

American Radio Institute  
Appliance Training School  
Candler System  
Commercial Radio Institute  
Lincoln Engineering School  
Melville Radio School  
RCA Institutes, Inc.  
Western Radio  
Y.M.C.A.

Radio Dealers Supply Co. ....	657
Radio Distributing Co. ....	655
Radio Electric Service. ....	644
Radio Kits Co. ....	656
Radio Maintenance ....	599
Radio Product Sales Co. ....	651
Radio & Television Supply Co. ....	657
Radio Wire Television, Inc. ....	640
Radolek Co. ....	659
Roehr Distributing Co. ....	657
Rosierucians ....	651
Sams, Inc., Howard W. ....	626
Sigmon Radio Supply ....	642
Solar Capacitor Sales Corp. ....	
Inside Front Cover	
Sperry Gyroscope Co. ....	625
Sprague Products Co. ....	592
Sprayberry Academy of Radio ....	593
Superior Instruments Co. ....	591
Supreme Publications ....	655
Sylvania Electric Prods. Co. ....	590
"Tab" ....	646
Telex Inc. ....	653
Terminal Radio ....	637
Triplett Elec. Instrument Co. ....	643
Trutone Products Co. ....	657
Turner Company, The ....	623
Western Radio Institute. ....	657
Weston Elec. Instrument Co. ....	
Inside Back Cover	
World Radio Laboratories ....	648
X. L. Radio Labs. ....	653

## A.C.-D.C. "B" BATTERY

(Continued from page 657)

insure greater stability, a 10,000-ohm 2-watt bleeder was placed in the circuit from B-plus to ground, giving a 10-ma bleeder current and dropping the output voltage to 91 volts. Also this bleeder current flows through the 1000-ohm resistor at 10 ma, producing a 1-volt drop. Voltage output is now 90, with receivers drawing 16 ma of current. Most 6-tube battery receivers draw about this much. The miniature tube variety draws around eight or nine ma. The filament supply was omitted because the cathodes of the 117Z6 will not safely pass the additional current. The battery male plugs could still be used if one plug was shorted out with a piece of wire. Tape up the remaining male plug.

The chassis was constructed from galvanized sheet metal of 3/32 material 3 1/2 inches wide, 4 1/2 inches long and 2 1/4 inches deep. 1/8-inch holes were drilled and placed along the bottom and

sides for tube ventilation. A female socket was torn from one of the old "B" batteries and placed in the top of the chassis.

## SPECIALS

1 1/4 x 1 1/4 x 2 1/2 Universal 455-456 I. F. Transformers	\$0.49
Output Transformers Small Pentode for 50L6, etc. ....	.69
D.P.S.T. Toggle Switches ....	.25
160 Ma. 6.3V.-5V. "A" Mount Power Transformers STC ....	5.25
Curved Arm, High gain CRYSTAL PICKUPS ....	2.49

Write for Weekly Specials

**Massey's Radio Supply**

Phone 1474, 2992 8th St.  
RIVERSIDE, CALIFORNIA



## HARD-TO-GET PARTS

### POWERFUL ALL-PURPOSE INDUCTION MOTOR

IDEAL FOR EXPERIMENTERS—101 USES

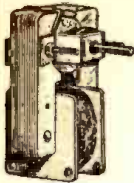

Sturdily constructed to precision standards, this self-starting shielded pole A.C. induction motor is powerful enough for a number of uses. Some of these are: Automatic Timing Devices, Current Transformers, Electric Fans, Electric Chimes, Window Displays, Photocell Control Devices, Electric Vibrators, Small Grinders, Buffers and Polishers, Miniature Pumps, Mechanical Mod. els, Sirens, and other applications.

Consumes about 15 watts of power and has a speed of 3,000 r.p.m. When geared down, this sturdy unit will constantly operate an 18-inch turntable loaded with 200 lbs. dead weight—THAT'S POWER! Dimensions 3" high by 2" wide by 1 3/4" deep; has 4 convenient mounting studs; shaft is 1/8" long by 3/16" diameter, and runs in self-aligning oil retaining bearings. Designed for 110-220 volts, 50-60 cycles, A.C. only. Shp. Wt. 2 lbs.

ITEM NO. 147  
YOUR PRICE ..... \$2.95

### ULTRA MAGNET

LIFTS MORE THAN 20 TIMES ITS OWN WEIGHT

LITTLE GIANT MAGNET



Lifts 5 lbs. easily. Weighs 4 oz. Made of ALNICO new high-magnetic steel. Complete with keeper. World's most powerful magnet ever made. The experimenter and hobbyist will find hundreds of excellent uses for this high quality permanent magnet. Measures 1 3/4" x 1 1/2" Shp. Wt. 2 1/2 lbs.

ITEM NO. 159  
YOUR PRICE ..... \$1.50

### GENUINE MICROPHONE TRANSMITTERS

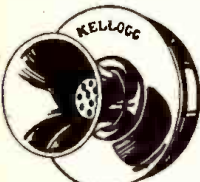

Regular telephone transmission taken from a large telephone supply company's overstock. Work perfectly on dry cells. Can be used on P.A. systems, call systems, intercommunications, c.t.s., short-line telephone circuits, house-to-house or farm-to-farm "phone lines," also to talk through your own radio or an concealed telephone pick-up. Useful replacements on battery-operated rural telephone lines.

THESE ARE GENUINE TRANSMITTERS, MADE BY KELLOGG WESTERN ELECTRIC AND STROMBERG-CARLSON, excellent in appearance and operation. A remarkable value and one seldom offered in these times. Shp. Wt. 1 lb.

ITEM NO. 160  
YOUR PRICE ..... \$1.50

### AMAZING BLACK LIGHT!

Powerful 250-Watt Ultra-Violet Source



The best and most practical source of ultra-violet light for scientific, experimental and entertainment use. Makes all fluorescent substances brilliantly luminescent. No transformers of any kind needed. Fits any standard lamp socket. Brings out beautiful opalescent hues in various types of materials. Swell for amateur parties, plays, etc. To obtain unique lighting effects. Bulb only. Shp. Wt. 2 lbs.

ITEM NO. 87  
YOUR PRICE ..... \$1.95

### WESTERN ELECTRIC BREAST MIKE

This is a light-weight aircraft carbon microphone. It weighs only 1 lb.



Mike comes with breathing mounting and has 2-way swiveling adjustment so that it can be adjusted to any desired position. There are 2 woven straps, one goes around neck, the other around chest. Straps can be slung on and off quickly by an ingenious arrangement.

This excellent mike can be adapted for home broadcasting or private communication systems. By dismounting bracket plate, it can be used as desk mike.

Comes complete with 6-foot cord and hard rubber plug. Finished in silver-plated plate, non-rustable. Shipping weight, 2 lbs.

ITEM NO. 152  
YOUR PRICE ..... \$1.49

### WATTHOUR METER



Completely overhauled and ready for immediate service. Designed for regular 110-volt, 60 cycle 2-wire A.C. circuit. Simple to install: 2 wires to the line and 2 wires to the load. Sturdy, fully constructed in heavy metal case. 8 1/2" high, 6 1/2" wide, 5" deep. Weights, 1 lb. 10 oz. Made in U.S.A. Sanborn or other available make. Shp. Wt. 14 lbs.

ITEM NO. 33  
YOUR PRICE ..... \$5.50

HUDSON SPECIALTIES CO.  
43 West Broadway, Dept. RC-6-46, New York 7, N.Y.

I have circled below the numbers of the items I'm ordering. My full remittance of \$..... is enclosed (include shipping charges) is enclosed (NO C.O.D. ORDERS UNLESS ACCOMPANIED WITH A DEPOSIT.) OR my deposit of \$..... is enclosed (20% required) ship order C.O.D. for balance. NO C.O.D. ORDER FOR LESS THAN \$5.00. BE SURE TO INCLUDE SHIPPING CHARGES. Circle item No. wanted:

147    159    160    87    152    33

Name .....

Address ..... Please Print Clearly

City ..... State .....

## BOOK REVIEWS

**TELEVISION SIMPLIFIED**, by Milton S. Kiver. Published by D. Van Nostrand Co., Inc. Stiff cloth covers, 5 1/2 x 8 1/2 inches, 375 pages. Price \$4.75.

Few practical books on this subject have been written for the serviceman or technician lacking knowledge of engineering mathematics, and equally lacking in patience to follow dissertations on the historical or economic aspects of the art to get a little information as to the how and why of television.

The author of this work plunges immediately into detail after a single introductory chapter which describes the general features of television receivers and transmitters, scanning, camera tubes, the need for wide transmission bands and other points necessary to present a broad general idea of the subject.

The second chapter discusses u.h.f. waves and suitable television antennas. From here the author goes into r.f. and i.f. circuits, detectors, a.g.c. circuits, video amplifiers, d.c. reinsertion, cathode-ray tubes, synchronizing and deflecting circuits.

Having covered the circuit details, the author proceeds to deal with typical television receivers and their adjustment. A long chapter (36 pages) is devoted to servicing television sets. Some space is given to special circuits, color television and the frequency modulation used for the audio transmissions associated with television programs. A glossary of television terms and a brief index complete the book.

**INSIDE THE VACUUM TUBE**, by John F. Rider. Published by John F. Rider, Inc. Stiff cloth covers, 5 1/2 x 8 1/2 inches, 407 pages plus preface and table of contents. Price \$4.50.

For the first time in a book intended for the student or beginner, a modern approach is made to the theory and operation of electron tubes. After a brief introduction to electrons and thermionic emission, vacuum-tube action is considered on a basis of fields and charges. The result is a clearer and by no means less simple explanation of the tube and its workings than has hitherto appeared.

Though the attack is from the same point as an advanced text, the manner of presentation is kept to the beginner's level, and the material is lightened by illustrative cartoons which fully explain electronic laws and tube operation. Another interesting departure in illustration is the three-dimensional drawings, which when viewed through the red-blue spectacles provided with the book permit the reader to visualize actions which cannot be presented properly in a flat two-dimensional picture.

After describing why and how the tube functions, its characteristics as a part of electronic apparatus are considered, and a number of chapters are given to dynamic curves, transfer characteristics, voltage and power ampli-

(Continued on following page)

## KWIKHEAT

is best

12 ways

From Tip-to-Plug  
in a Class by Itself

**FAST!** Hot in Only 90 Seconds

**COOL** New Protecting Handle

**SAFE!** Will Not Overheat

**POWERFUL** (Full 225 Watts)

**SAVES TIME**—Less Retinning

**BALANCED!** Easily Handled

**DEPENDABLE**—Longer Lasting

**LIGHT WEIGHT** (Only 13 1/2 oz.)

**THREADED TIPS** For Best Contact

**ECONOMICAL** in Operation

**THERMOSTAT** is Built In

**SIX TIP STYLES** interchangeable

**A KWIKHEAT USER WRITES—**

"I am certainly convinced that Kwikheats are the best irons that can be obtained. They are really a pleasure to work with."

H. P. K. Long Branch, N. J.

225-Watt Iron with #1 Tip **\$11**

Extra Tips—Six Styles, each 1.25

VANATTA

## KWIKHEAT

THERMOSTATIC SOLDERING IRON

A Division of  
Sound Equipment Corporation of California  
3903 San Fernando Rd., Glendale 4, California

# RADOLEK

## Radio-Electronic Service Parts

Large stocks assure the finest and most complete selections of all available items at lowest prevailing prices. Thousands of active buyers depend on us for their entire Radio repair and replacement requirements. Because we understand service problems, every order is expedited for delivery in double quick time. Everything we do is planned for convenience and satisfaction to our customers. You will find it profitable to make Radolek your buying headquarters.

### FREE BUYING GUIDES

Because of existing conditions we keep our customers right up to the minute on available merchandise by releasing supplements frequently instead of sending our regular Big Profit Guide once a year. Send the coupon now to get these Free Buying Guide Supplements as they are issued.

**FREE!**

**RADOLEK**

Buying Guide

RADOLEK COMPANY

### FAST SERVICE!

RADOLEK CO., Dept. C-115  
601 W. Randolph St., Chicago 6, Ill.

Please send FREE Buying Guide Supplements

NAME .....

ADDRESS .....

## ORDER FROM RADOLEK

# RADIO SCHOOL DIRECTORY

PREPARE NOW FOR SKILLED JOBS IN RADIO AND ELECTRONICS

MAKE a place for yourself in a new world of radio and electronics—a world in which revolutionary electronic developments will require highly specialized technical knowledge. Take a good course now to fit yourself for a good paying job. The training you need can be supplied by one of the schools advertised in this publication.

**BE YOUR OWN BOSS — OPERATE YOUR OWN PROFITABLE BUSINESS**

## HOME and INDUSTRIAL APPLIANCES

**SERVICE—REPAIR—INSTALLATION**

ONLY shop training course of its kind. Gives you actual shop training on washing machines, mangles, heat control systems, water heaters, toasters, vacuum sweepers, etc., etc. Work on actual machines under trained instructors. Low tuition. Old established school. Most complete training course of its kind. Investigate this opportunity—its money-making possibilities and the need for trained men. Write today for details. No obligation.

Veterans ask for GI plan. Act now!

**APPLIANCE TRAINING SCHOOL—Dept. 56**

Division of Commercial Trades Institute  
6312 N. Broadway, Chicago 40, Ill.



## RADIO

Train with professionals. Complete intensified courses: Repair & Maintenance, Communications, High-speed telegraphy, Slip transcription, FCC exams, etc.

High School Students accepted for training as Merchant Marine Radio Officers.

Gov't sponsorship available to veterans.

"A Radio School managed by radio men."  
45 W. 45th St., Dept. RC, New York 19, N.Y.  
**MELVILLE RADIO INSTITUTE**

## COMMERCIAL RADIO INSTITUTE

A radio training center for twenty-five years.

### RESIDENT COURSES ONLY

Broadcast, Service, Aeronautical, Television and Marine telegraphy classes now forming. Literature upon request. Veteran training. Classes now forming for July 1st. Dept. C, 38 West Biddle St., Baltimore 1, Md.

## LEARN RAPID RADIO SERVICING

Send for Free Information: "3 Ways to Learn Radio." Approved for Training Veterans. (See our ad on page 657)

**WESTERN RADIO INSTITUTE**  
1457 Glenarm, Denver 2, Colo.

## BOOK REVIEWS

(Continued from page 659)

fiers, and even the cathode follower. Miscellaneous tubes, including cathode-ray and photoelectric types, are described in the last chapter.

The book lacks an index, but this omission is balanced by complete sub-heading in the table of contents.

## WORLD-WIDE STATION LIST

(Continued from page 622)

Freq.	Station	Location and Schedule
17.700	GVP	LONDON, ENGLAND: Netherland Indies, 6 to 6:15 am; 7 to 7:15 am; Chinese beam, 5:30 to 6 am; African beam, 6:30 to 6:45 am.
17.715	GRA	LONDON, ENGLAND.
17.730	GVQ	LONDON, ENGLAND: Near East beam, 1:30 to 10:15 am; Central and South American beam, 6 to 10:15

**RCA INSTITUTES, Inc.**  
Offer thorough training courses in all technical phases of **Radio and Television** WEEKLY RATES  
**VETERANS:** RCA Institutes is approved under G. I. Bill of Rights  
For Free Catalog Write Dept. RC.46  
**RCA INSTITUTES, Inc.**  
A RCA Corporation of America Service  
75 VARICK STREET NEW YORK 13, N. Y.

**RADIO COURSES**  
● RADIO OPERATING ● CODE  
● RADIO SERVICING — ELECTRONICS  
● REFRIGERATION SERVICING  
Personal Counselling Services for Veterans  
Write for Latest Trade & Technical Catalog  
**Y.M.C.A. TRADE & TECHNICAL SCHOOLS**  
4 W. 64th Street New York City

**RADIO**  
RADIO Technician and Radio Communications courses. Register now for new classes starting first MONDAY of each month. Day and Evening Classes.  
**AMERICAN RADIO INSTITUTE**  
101 West 63rd St., New York 23, N. Y.  
APPROVED UNDER GI BILL OF RIGHTS.

**CODE SENDING SPEED**  
**RECEIVING SPEED**  
Be a "key" man. Learn how to send and receive messages in code by telegraph and radio. Commerce needs thousands of men for Jobs. Good pay, adventure, interesting work. Learn at home quickly through famous Candler System. Write for FREE BOOK.  
**CANDLER SYSTEM CO.**  
Dept. J-G, Box 928, Denver 1, Colo., U.S.A.

**LES** Correspondence Courses in **RADIO and ELECTRICAL ENGINEERING**  
**ELECTRICAL ENGINEERING** Get good grasp of wide electrical field. Prepare yourself, at Low Cost, for secure future. Modern, simplified, you can understand quickly.  
**RADIO ENGINEERING** Get address, photo-electric work. Trains you to be super-service man, real vacuum tube technician. Servicemen needed badly. Diploma on completion. Tuition \$25, either course. Deferred payment plan.  
**FREE** Get copies of school catalogs, student magazines, complete details. SEND NOW!  
**LINCOLN ENGINEERING SCHOOL** Box 931C-88, Lincoln, Nebr.

17.750	WRUW	am: 11:45 am to 4 pm; Indian beam, 1:30 to 4 am.
17.760	KWID	BOSTON, MASS.: Central American beam, 6:30 to 8:15 pm; European beam, 9 am to 12:45 pm.
17.765		SAN FRANCISCO, CALIF.: South American beam, 5 to 7:30 pm.
17.770	OTC	PARIS, FRANCE: 6 to 8 am.
17.780	WNBI	LEOPOLDVILLE, BELGIAN CONGO: 6 to 9:30 am; 11:30 am to 12:15 pm.
17.780	KNBA	NEW YORK CITY: South American beam, 5 to 6:15 pm; European beam, 7:30 am to 1 pm.
17.790	GSG	SAN FRANCISCO, CALIF.: South Pacific beam, 2 to 4:45 pm.
17.800	WLWO	LONDON, ENGLAND: African beam, 11 am to 2:15 pm.
17.800	KRHO	CINCINNATI, OHIO: South American beam, 5 to 5:45 pm; European beam, 7:30 am to 2:30 pm.
17.800	OIX5	HONOLULU, HAWAII: Philippine beam, 4 to 11:30 am.
17.810	GSV	LAHTI, FINLAND: 8 am to 12:30 pm.
17.820	CKNC	LONDON, ENGLAND: African beam, 4 to 10:15 am; Indian beam, 4 to 10:15 am.
17.830	WCBN	MONTREAL, CANADA: European beam, 7 am to 2 pm.
17.830	VUDI0	NEW YORK CITY: European beam, 6 am to 12:45 pm.
17.845		DELHI, INDIA: 5 to 7 am; BRUSSELS, BELGIUM: 6 to 7 am; 11 am to noon.
17.850	KCBF	LOS ANGELES, CALIF.: South American beam, 5 to 10:45 pm.
17.870	GRP	LONDON, ENGLAND: African beam, 10:30 am to 12 pm.
17.955	WLWI	CINCINNATI, OHIO: European beam, 8 am to 12:45 pm.
18.025	GRQ	LONDON, ENGLAND.

18.080	GVO	LONDON, ENGLAND: South American beam, 6 to 10:15 am; 11:45 am to 12:45 pm.
18.135	PMC	BATAVIA, NETHERLAND INDIES: 11:30 pm to 9:30 am.
18.160	WNRA	NEW YORK CITY: European beam, 6 am to 1:30 pm.
21.470	GSH	LONDON, ENGLAND: African beam, 9:15 to 10:45 am.
21.530	GSJ	LONDON, ENGLAND: Indian beam, 4 to 8:45 am.
21.550	GST	LONDON, ENGLAND.
21.640	GRZ	LONDON, ENGLAND.
21.675	GVR	LONDON, ENGLAND: 6 to 8:30 am.
21.710	GVS	LONDON, ENGLAND.
21.750	GVT	LONDON, ENGLAND.
25.750	GSQ	LONDON, ENGLAND.
26.100	GSK	LONDON, ENGLAND: Central and South African beam, 6:15 to 8:45 am.
26.400	GSR	LONDON, ENGLAND.
26.550	GSS	LONDON, ENGLAND.

## BETTER BROADCAST TUNER

(Continued from page 636)

### Parts List

### RESISTORS

- R1—10,000 ohms potentiometer
- R2, R3—100,000 ohms
- R4—400 ohms
- R5—10,000 ohms
- R6—50,000 ohms
- R7—60,000 ohms
- R8—400 ohms
- R9—10,000 ohms
- R10—60,000 ohms
- R11—5,000 ohms; 10 watts (optional if power supply is well filtered)

### CONDENSERS

- C1, C2, C3—gank condenser, .00086
- C4, C5, C6, C7, C8, C9—1 µf
- C10—8 µf, 450 volt electrolytic
- C11—0.001 µf mica
- C12—1 µf, 600 volt, tubular

### MISCELLANEOUS

- L1—14-7413 Meissner Iron Core shielded coils
- L2—14-7558 Meissner Iron Core shielded coils
- L3—14-7558 Meissner Iron Core shielded coils

## Radio Thirty-Five Years Ago

In Gernsback Publications

### HUGO GERNSBACK

Founder

Modern Electrics	1908
Electrical Experimenter	1913
Radio News	1919
Science & Invention	1920
Radio-Craft	1929
Short-Wave Craft	1930
Wireless Association of America	1908

Some of the larger libraries in the country still have copies of Modern Electrics on file for interested readers.

High Frequency Currents, by Norman Barden.

The Rosing Telephot.

Gaumont (Talking Machine) Apparatus.

New Bellini-Tosi Apparatus, by A. C. Marlowe.

Wireless Interference and Perturbations, by J. E. Taylor.

Unique Means to Vary Wave Length. Detector Recorders.

An Easily Constructed Variable Condenser, by James Bitler.

Light Portable Aerial, by John Brady.

Simple Electrolytic Interrupter, by Alfred Bretonnel.

Electromagnetic Reproducer, by Frode Jensen.

Sending Condenser for One-Inch Coil, by J. McClain.

Simple Sending Condenser, by N. C. Goim.

An Adjustable Condenser, by W. Schurmann.

Break-In Key, by C. W. Carlstrom.

A New Ball-Bearing Slider, by O. J. Hurlbut.

Pocket Radio Receiver, by L. O. Mumford.



S. WILLARD BRIDGES  
293 SUMMER STREET  
BOSTON 10, MASSACHUSETTS

April 9, 1946

Panoramic Radio Corp.  
242 West 55th Street  
New York 19, N.Y.

Attention: Mr. Bernard Schlessel

Gentlemen:-

It is seldom that I have purchased a piece of radio equipment and found it far superior to my expectations, but the Panadaptor that I purchased from the Radio Shack in Boston about two weeks ago has certainly out-performed anything I had hoped for.

I have used the Panadaptor primarily as a monitor for the 10 meter band in conjunction with an NC 200 Receiver, and I find it priceless for band coverage between transmissions. Today I discovered I was paying no attention whatsoever to the receiver dial but was controlling my receiver entirely from the scope screen where I could see the field both sides of the frequency to which I was tuned.

This is a fine unit and I know you will sell a great many of them.

Yours very truly,

*S. Willard Bridges*  
S. Willard Bridges

awb:k

# "PRICELESS"

FOR BAND COVERAGE . . .

CONTROLLING RECEIVER ENTIRELY . . .

Letters arrive daily . . . all enthusiastic

. . . all agree that PANADAPTOR

.. out-performs anything hoped for ..

To fully appreciate ALL that this amazing instrument offers, you must SEE

## PANORAMIC RECEPTION

"Blind" operation is now a thing of the past . . . as outdated as the kerosene lamp for illuminating your home. Some radio amateurs may continue to "rough" it without a PANADAPTOR . . . but all modern shacks will have it.



**PANADAPTOR Model PCA-2**  
Now Available at Leading Radio Parts Jobbers. Ask for demonstration. Amateur Net Price, complete with ten tubes and accessories for 115 V., 50-60 cycle operation.  
**\$99.75**

**ONE YEAR GUARANTEE**  
against defects in parts or workmanship (excluding tubes). Panoramic Handbook with full installation, operating, application and maintenance instructions furnished with each PANADAPTOR.

PANADAPTOR is the "EYE" of your rig. It lets you SEE holes in busy bands, SEE the signal characteristics of your own and other stations, SEE short calls. It shows you 200 kc of any band instantly, helps you locate your sked and avoid annoying QRM. PANADAPTOR makes radio more fun for you, by making operation of your station more efficient . . . smoother . . . easier. You owe it to yourself to see the PANADAPTOR - now on display at leading radio jobbers.

Exclusive Canadian Representative: CANADIAN MARCONI, Ltd.

PANADAPTOR, featuring PANORAMIC RECEPTION, is the exclusive and original design of PANORAMIC RADIO CORPORATION

### PANORAMIC

CABLE ADDRESS  
PANORAMIC, NEW YORK



### RADIO CORPORATION

242-250 WEST 55th ST. New York 19, N.Y.